

WL01.2701.32.SS

Grünzell®

Description

Single body wall luminaire for indoors and outdoors, also harsh environments. No visible hardware. Made of stainless steel SS316. Narrow beam(NB)TIR-lens made of PMMA. High power LED. Different light distributions and colour temperatures can be achieved with accessory filters.

Clear covers made of 10mm thick PMMA sealed with Silicone gaskets.

Mounted to any flat surface with ST4.8 wood screws

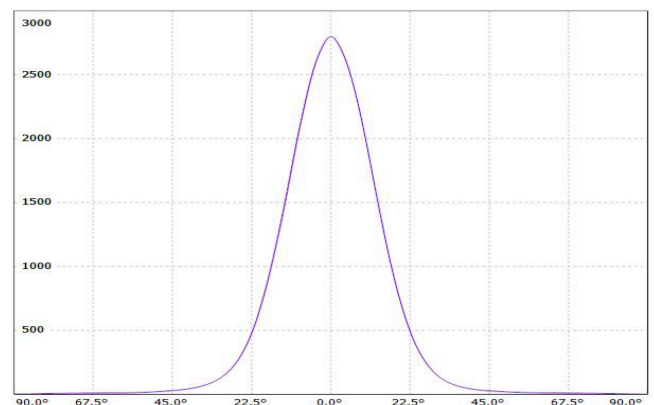
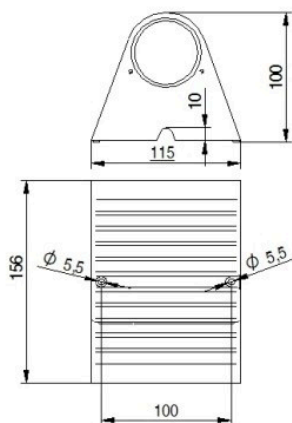
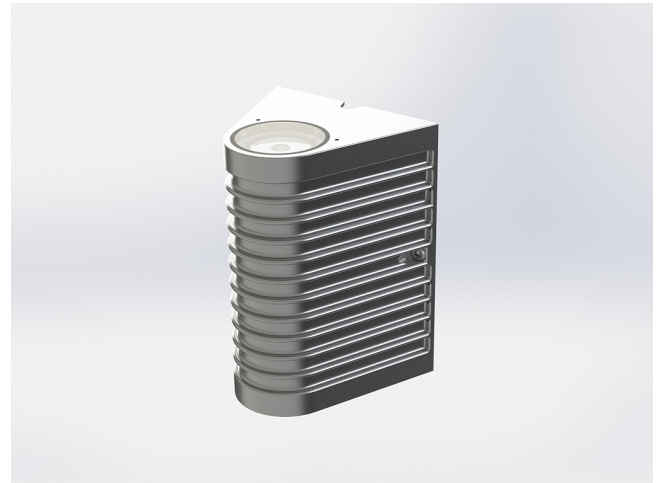

LED Lamp	1
Luminous Flux	840 lm
Colour temperature	2700 K
CRI	80
MacAdam Ellipse	3 Step
Nominal Power	10W
Beam Angle	32°

Ingress Protection	IP66
Impact Protection	IK10
Body	Cast Stainless Steel 316
Weight	1.6 kg
Finish	Power coat finish in white RAL9016, grey RAL9006 or black 9005
Line Voltage	100 ~ 270V / 50-60Hz
Electrical Gear	IP67 LED Driver in a thermally separated compartment

WL01.2701.32.SS

Grünzell®

Optical Accessories

Snoot
Stainless Steel

Spektor_49 Snoot

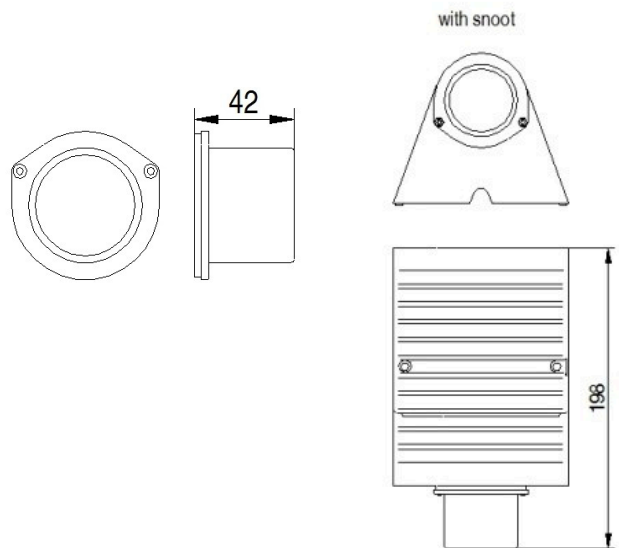

Glare Shield
Stainless Steel

Spektor_49 Glare Shield

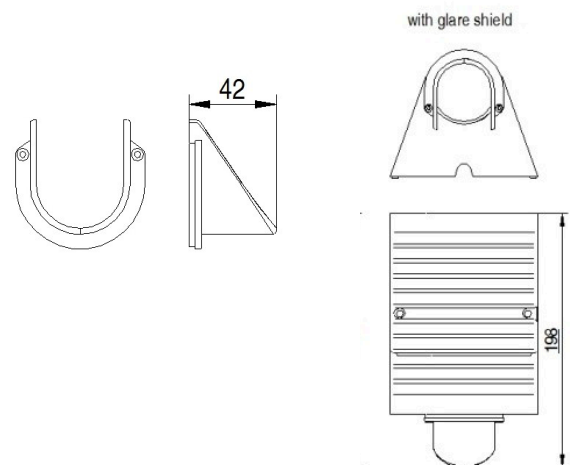

WL01.2701.32.SS

Grünzell®

Optical Accessories

Lenses and Filters

Spektor_49 Lenses and Filters and Honeycomb Louvre

