

SPL04.4001.70

Grünzell®

Description

At only 1W and $\varnothing 20\text{mm}$ the Mini-LIGHTZ are tiny but mighty. For Indoor or Outdoor use. Ideal for pathway lighting, garden lighting, recess into soffits, mount into handrails, garden beds, recessed into decking, balustrades or place it inside the house to illuminate hallways, stairways and cabinets.

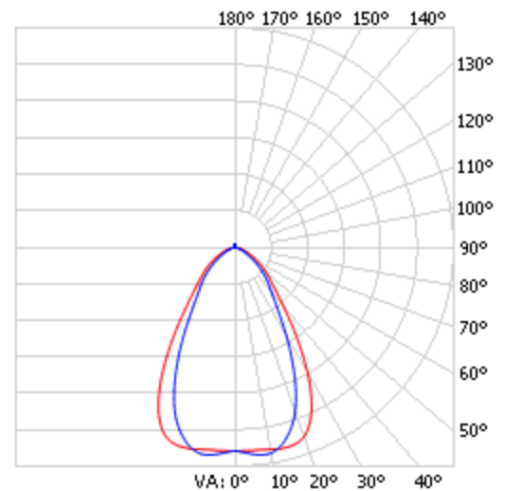
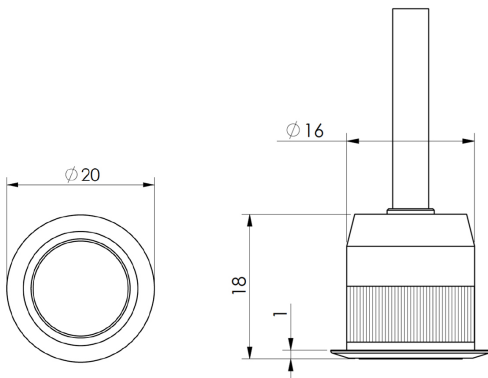

LED Lamp	1
Luminous Flux	100 lm
Colour temperature	4000 K
CRI	80
MacAdam Ellipse	3 Step
Nominal Power	1W
Beam Angle	70°

Ingress Protection	IP67
Impact Protection	IK08
Body	Black Anodized Aluminium, Natural Anodised Aluminium, Stainless Steel or Copper

Weight	-
Line Voltage	100 ~ 270V / 50-60Hz
Electrical Gear	IP67 LED Driver (supplied separately)

SPL04.4001.70

Grünzell®

Mounting Accessories

Spring Mount

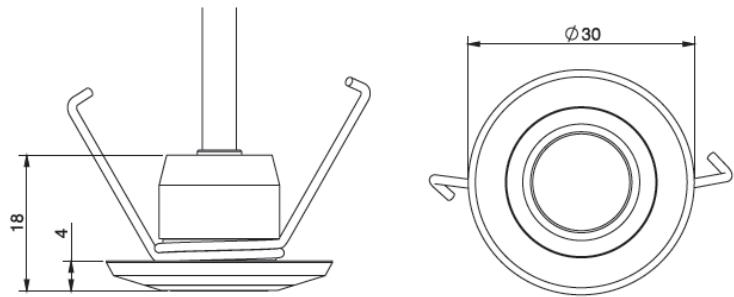

Spike Mount

200mm x 20mm

