

SPL03.4001.15

Grünzell®

Description

The 5W Mitsu Spot is excellent for both indoor and exterior use. Its durable construction makes it ideal for illuminating architectural elements, garden features and outdoor living spaces. Its attractive design also makes it ideal for indoor feature lighting or as a reading light

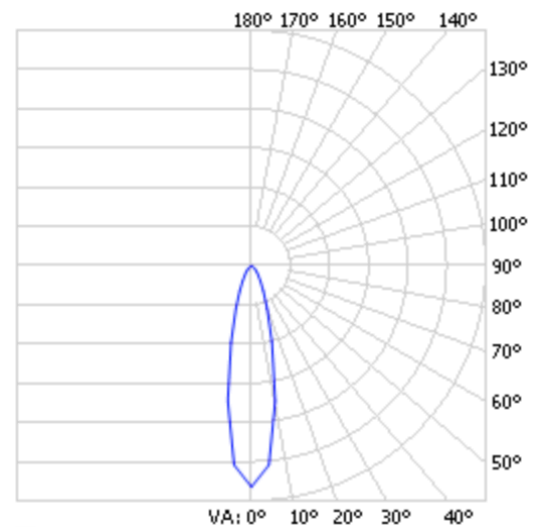
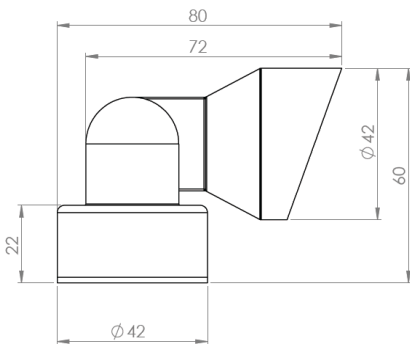

LED Lamp	1
Luminous Flux	415 lm
Colour temperature	4000 K
CRI	80
MacAdam Ellipse	3 Step
Nominal Power	5W
Beam Angle	15°

Ingress Protection	IP67
Impact Protection	IK08
Body	Natural Anodised Aluminium, Black Anodized Aluminium or Stainless Steel (316)

Weight	-
Line Voltage	100 ~ 270V / 50-60Hz
Electrical Gear	IP67 LED Driver (supplied separately)

SPL03.4001.15

Grünzell®

Mounting Accessories

Spike Mount
Black Anodized or Natural Anodized Aluminium

