

SPL02.4001.06.B

Grünzell®

Description

IP67 Class I LED Spotlight with built in LED driver. Single body made of solid bronze with more than 90% copper for versatile mounting and harsh environments. Narrow TIR-lens made of PMMA. Highly efficient high power LED. Different light distributions and colour temperatures can be achieved with accessory filters. Mounting slot, 11mm wide, allowing fixation and aiming with single bolt/screw.

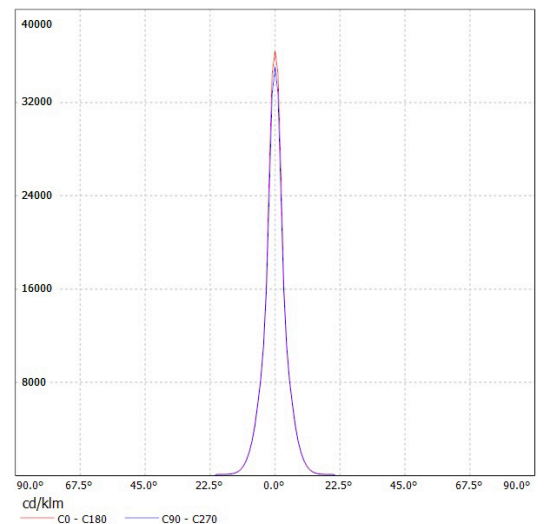
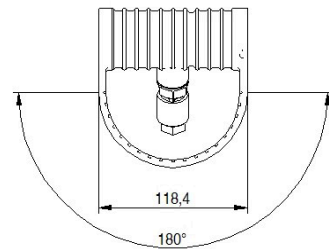
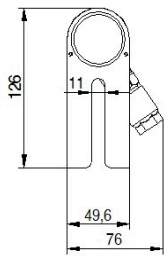
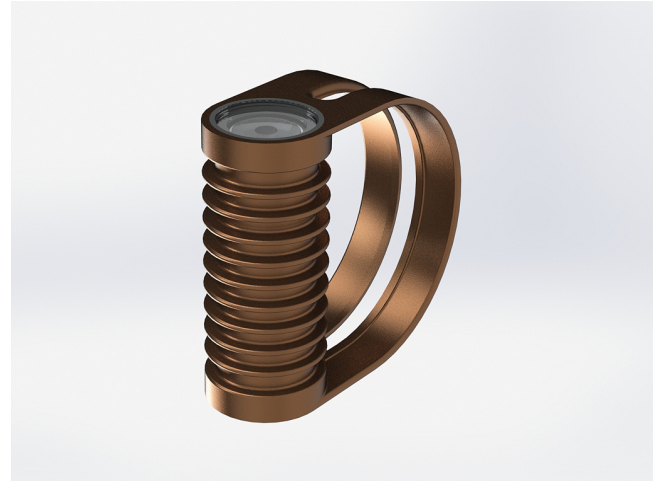

LED Lamp	1
Luminous Flux	656 lm
Colour temperature	4000 K
CRI	80
MacAdam Ellipse	3 Step
Nominal Power	7W
Beam Angle	6°

Ingress Protection	IP67
Impact Protection	IK10
Body	Die cast Bronze (> 90% copper)
Weight	0.93kg
Line Voltage	100 ~ 270V / 50-60Hz
Electrical Gear	IP67 LED Driver in a thermally separated compartment

SPL02.4001.06.B

Grünzell®

Mounting Accessories

Pedestal
Bronze

EQUUS Pedestal

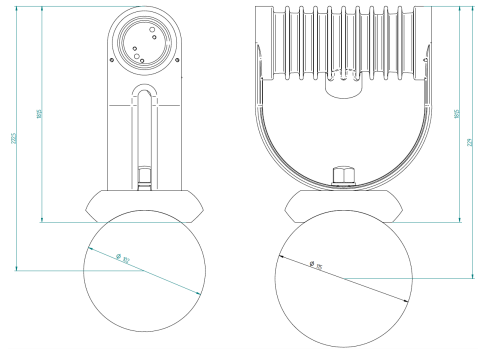

Optical Accessories

Snoot
Bronze

Spektor_39 Snoot

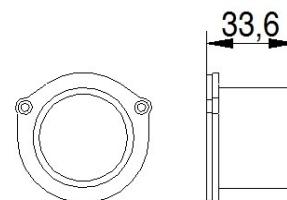
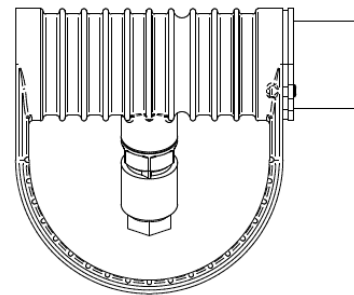

Optical Accessories

Glare Shield
Bronze

Spektor_39 Glare Shield

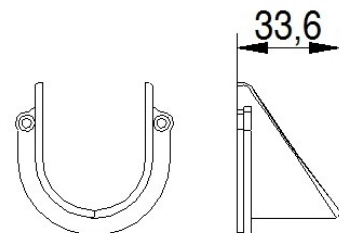
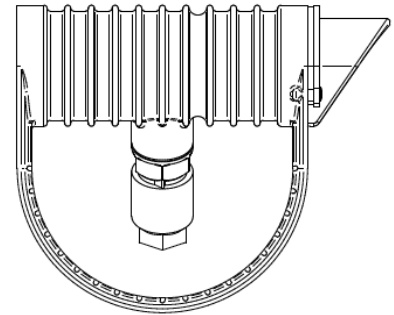

Lenses and Filters

Spektor_39 Lenses and Flim Filters and
Honeycomb louvre

