

SPL01.2701.32.SS

Grünzell®

Description

IP67 Class I LED Spotlight with built in LED driver. Single body made of solid stainless steel (SS316) for versatile mounting. Narrow TIR-lens made of PMMA. Highly efficient high power LED. Different light distributions and colour temperatures can be achieved with accessory filters. Mounting slot, 11mm wide, allowing fixation and aiming with single bolt/screw.

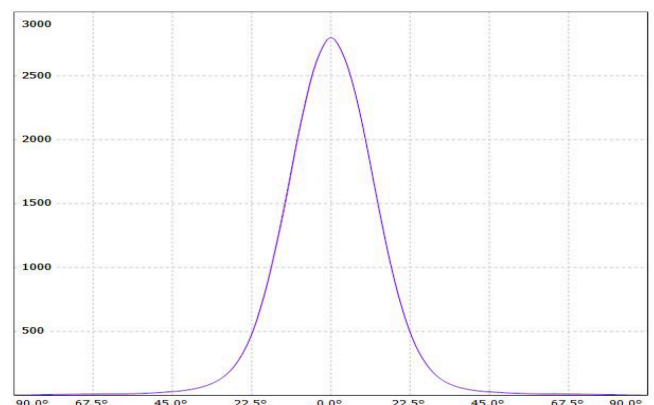
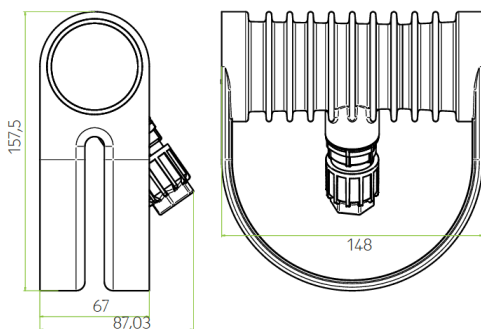
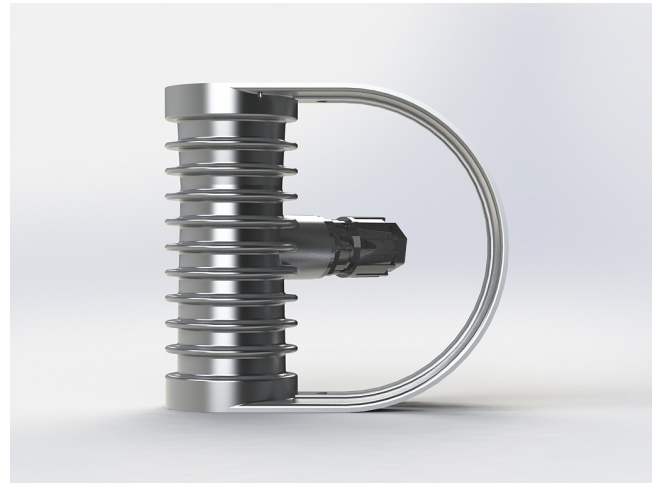

LED Lamp	1
Luminous Flux	1080 lm
Colour temperature	2700 K
CRI	80
MacAdam Ellipse	3 Step
Nominal Power	10W
Beam Angle	32°

Ingress Protection	IP67
Impact Protection	IK10
Body	Die cast Stainless Steel
Weight	1.6 kg
Finish	Power coat finish in white RAL9016, grey RAL9006 or black 9005
Line Voltage	100 ~ 270V / 50-60Hz
Electrical Gear	IP67 LED Driver in a thermally separated compartment

SPL01.2701.32.SS

Grünzell®

Mounting Accessories

Pedestal
Stainless Steel (316)

EQUUS Pedestal

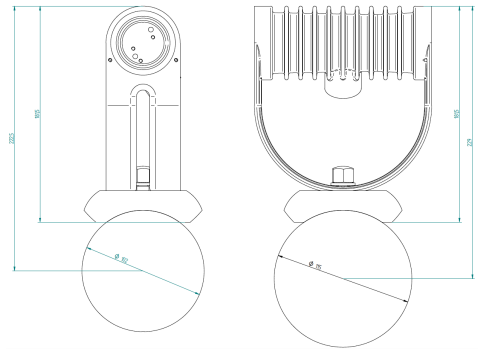
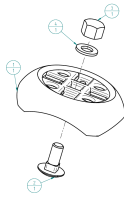

Optical Accessories

Snoot
Stainless Steel (316)

Spektor_49 Snoot

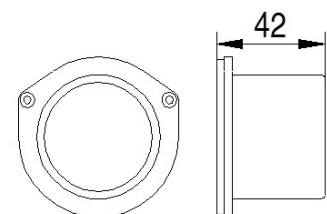
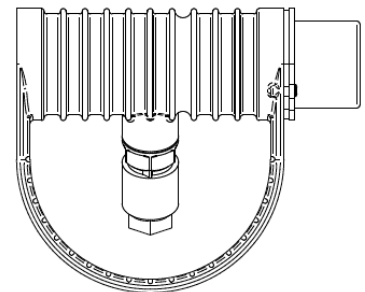

SPL01.2701.32.SS

Grünzell®

Optical Accessories

Glare Shield
Stainless Steel (316)

Spektor_49 Glare Shield

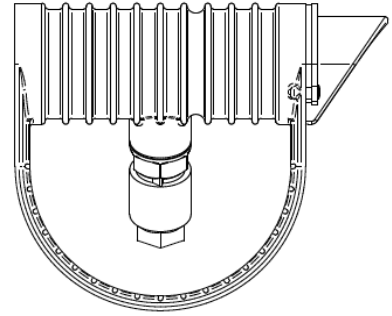

Lenses and Filters

Spektor_49 Lenses and Filters and Honeycomb
Louvre

