

# SPL01.2701.07.SS

Grünzell®

## Description

IP67 Class I LED Spotlight with built in LED driver. Single body made of solid stainless steel (SS316) for versatile mounting. Narrow TIR-lens made of PMMA. Highly efficient high power LED. Different light distributions and colour temperatures can be achieved with accessory filters. Mounting slot, 11mm wide, allowing fixation and aiming with single bolt/screw.

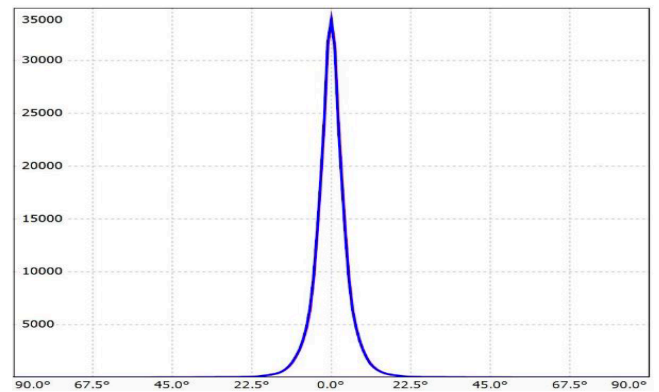
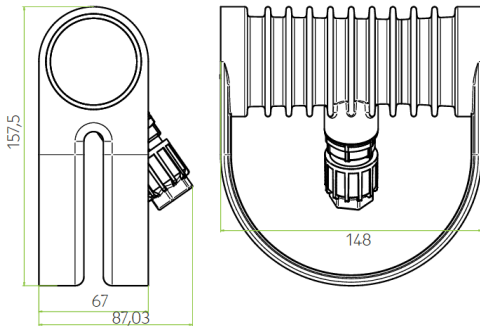
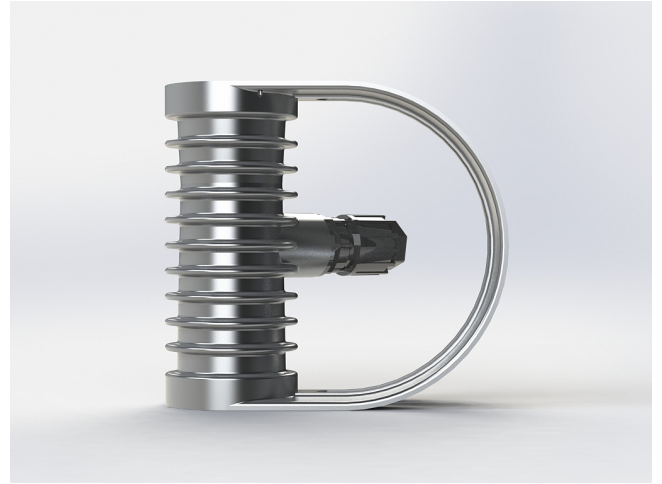

<b>LED Lamp</b>	1
<b>Luminous Flux</b>	840 lm
<b>Colour temperature</b>	2700 K
<b>CRI</b>	80
<b>MacAdam Ellipse</b>	3 Step
<b>Nominal Power</b>	10W
<b>Beam Angle</b>	7°

<b>Ingress Protection</b>	IP67
<b>Impact Protection</b>	IK10
<b>Body</b>	Die cast Stainless Steel
<b>Weight</b>	1.6 kg
<b>Finish</b>	Power coat finish in white RAL9016, grey RAL9006 or black 9005
<b>Line Voltage</b>	100 ~ 270V / 50-60Hz
<b>Electrical Gear</b>	IP67 LED Driver in a thermally separated compartment

# SPL01.2701.07.SS

Grünzell®

## Mounting Accessories

Pedestal  
Stainless Steel (316)

EQUUS Pedestal

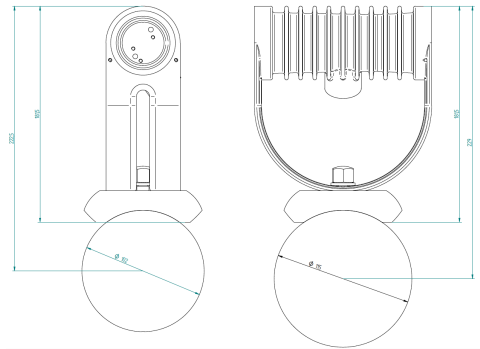
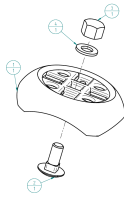

## Optical Accessories

Snoot  
Stainless Steel (316)

Spektor\_49 Snoot

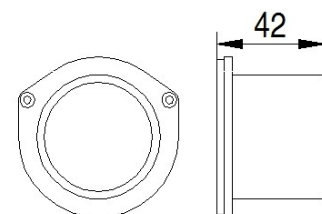
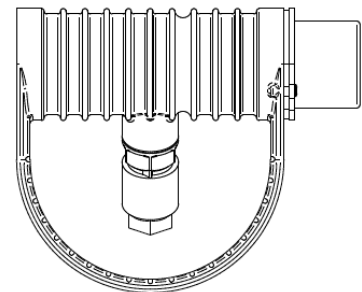

# SPL01.2701.07.SS

Grünzell®

## Optical Accessories

Glare Shield  
Stainless Steel (316)

Spektor\_49 Glare Shield

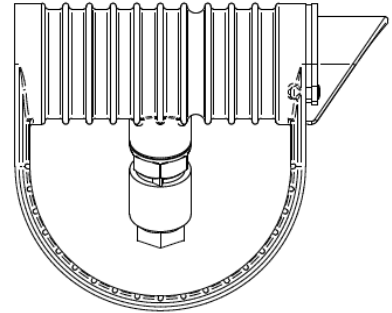

---

Lenses and Filters

Spektor\_49 Lenses and Filters and Honeycomb  
Louvre

