

# PL01.5008.SY

Grünzell®

## Description

Decorative LED luminaire for post top mounting. Suitable for glare-free illumination of shopping streets, pedestrian precincts, parks and other landscapes. Ideal for the refurbishment of old luminaires due to compatible 76 mm spigot diameter. Housing cover formed of aluminium sheet, support brackets and projector made of die-cast aluminium

Line Voltage: 100-277V, 50/60Hz. Removable built in driver (IP 67), replaceable LED head. All screws made of stainless steel. Light source by high performance COB LED in IP 65 projector with powder coated die-cast aluminium housing. Innovative lighting technology by secondary, glare free reflector system. Available with symmetrical or asymmetrical reflectors. Recommended mounting height 4-6 meters. Protection class: IP65 dust proof and water jet proof with featured GORE®Vent to protect the internal system from moisture.

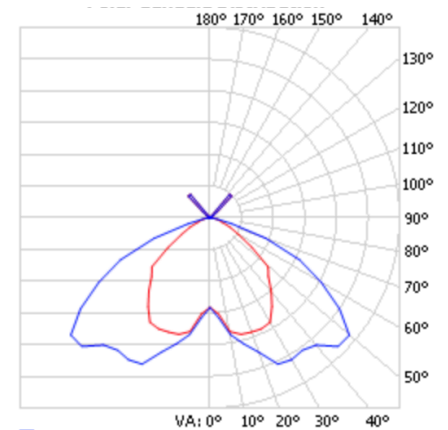
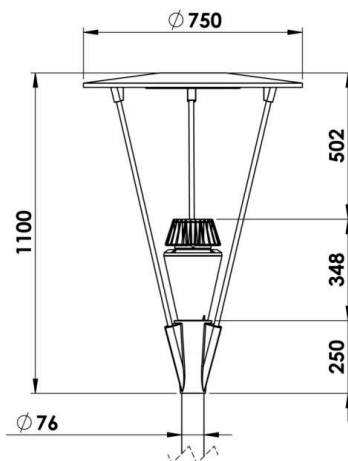

<b>LED Lamp</b>	1
<b>Luminous Flux</b>	9593 lm
<b>Colour temperature</b>	5000 K
<b>CRI</b>	80
<b>MacAdam Ellipse</b>	3 Step
<b>Nominal Power</b>	80W
<b>Beam Angle</b>	Symmetrical

<b>Ingress Protection</b>	IP65
<b>Impact Protection</b>	IK08
<b>Body</b>	Cast Aluminium
<b>Weight</b>	12.5 kg
<b>Finish</b>	Power coat finish in white RAL9016, grey RAL9006 or black 9005
<b>Line Voltage</b>	100 ~ 270V / 50-60Hz
<b>Electrical Gear</b>	IP67 LED Driver sold separately