

PL01.5008.AS

Grünzell®

Description

Decorative LED luminaire for post top mounting. Suitable for glare-free illumination of shopping streets, pedestrian precincts, parks and other landscapes. Ideal for the refurbishment of old luminaires due to compatible 76 mm spigot diameter. Housing cover formed of aluminium sheet, support brackets and projector made of die-cast aluminium

Line Voltage: 100-277V, 50/60Hz. Removable built in driver (IP 67), replaceable LED head. All screws made of stainless steel. Light source by high performance COB LED in IP 65 projector with powder coated die-cast aluminium housing. Innovative lighting technology by secondary, glare free reflector system. Available with symmetrical or asymmetrical reflectors. Recommended mounting height 4-6 meters. Protection class: IP65 dust proof and water jet proof with featured GORE®Vent to protect the internal system from moisture.

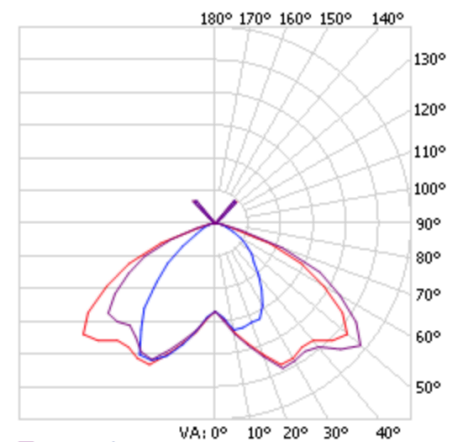
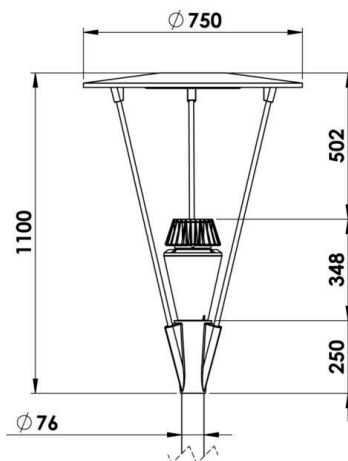

LED Lamp	1
Luminous Flux	9593 lm
Colour temperature	5000 K
CRI	80
MacAdam Ellipse	3 Step
Nominal Power	80W
Beam Angle	Asymmetrical

Ingress Protection	IP65
Impact Protection	IK08
Body	Cast Aluminium
Weight	12.5 kg
Finish	Power coat finish in white RAL9016, grey RAL9006 or black 9005
Line Voltage	100 ~ 270V / 50-60Hz
Electrical Gear	IP67 LED Driver sold separately