

PJL05.4001.47.x.xx

Grünzell®

Description

IP65 Class I LED Projector with remote LED driver. Surface powder coated corrosion resistant die cast aluminium alloy housing. Featured GORE®Vent to protect the internal system from moisture. Silicon rubber gasket and stainless steel 316 screws. Highly specular reflector. Tempered glass cover. COB LED with socket.

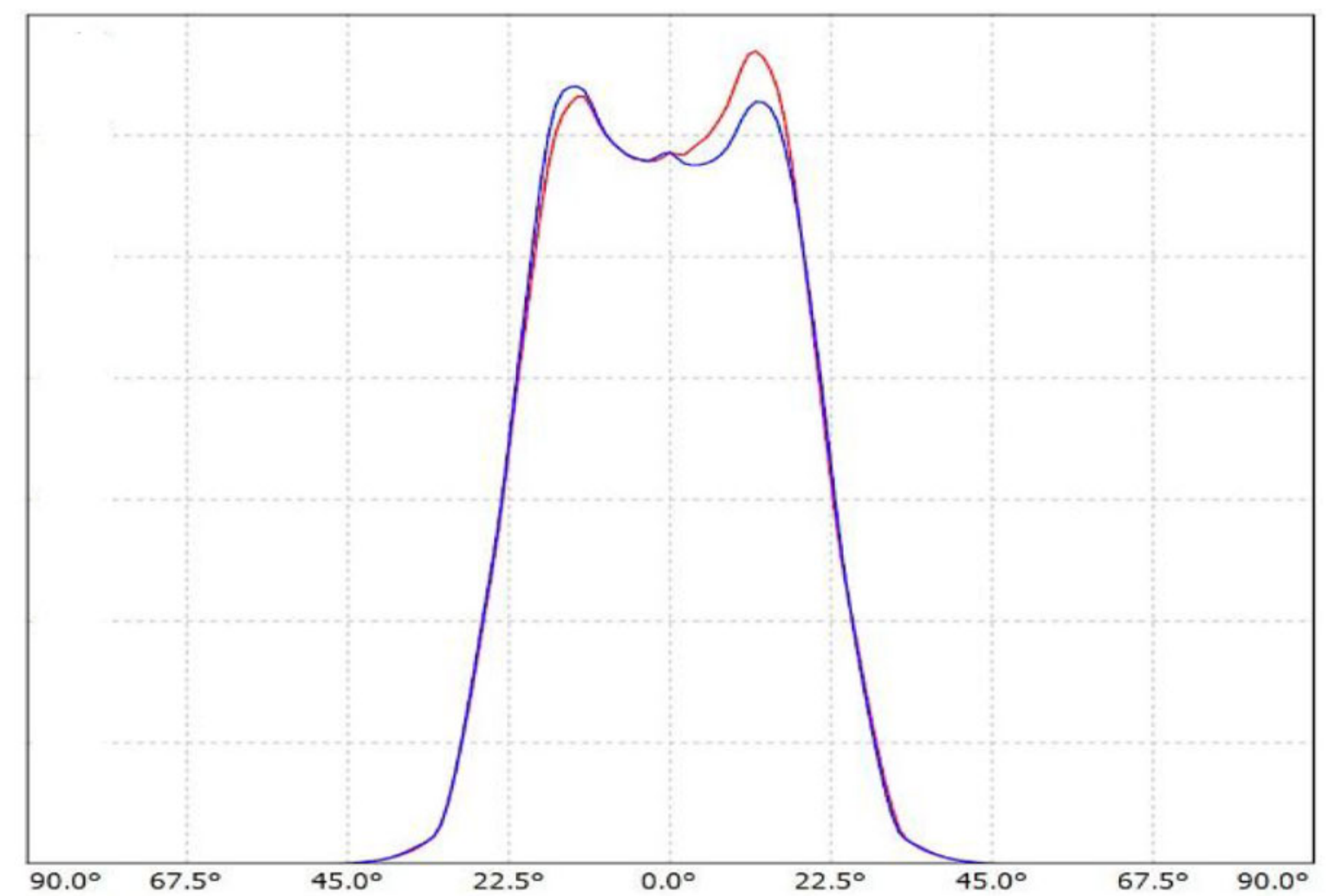
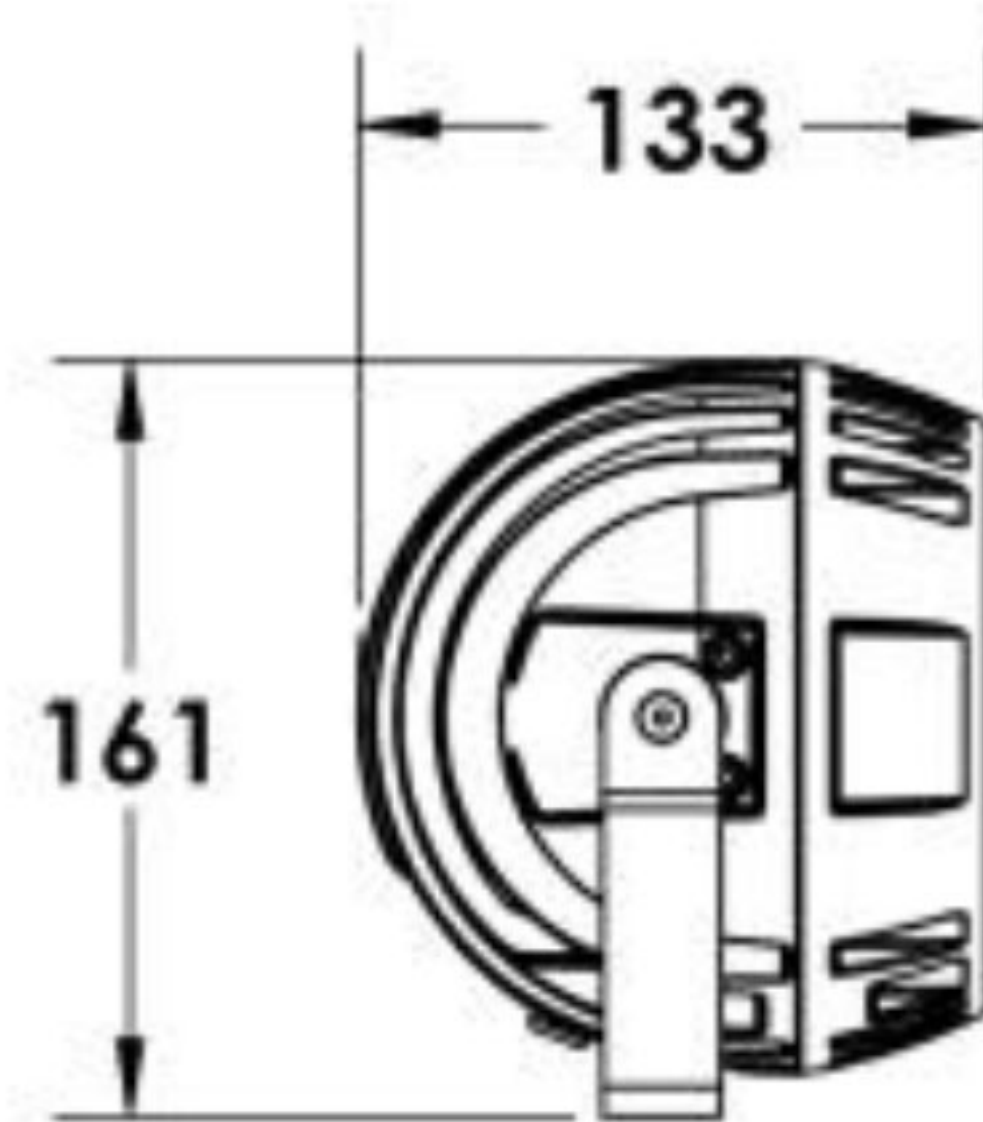
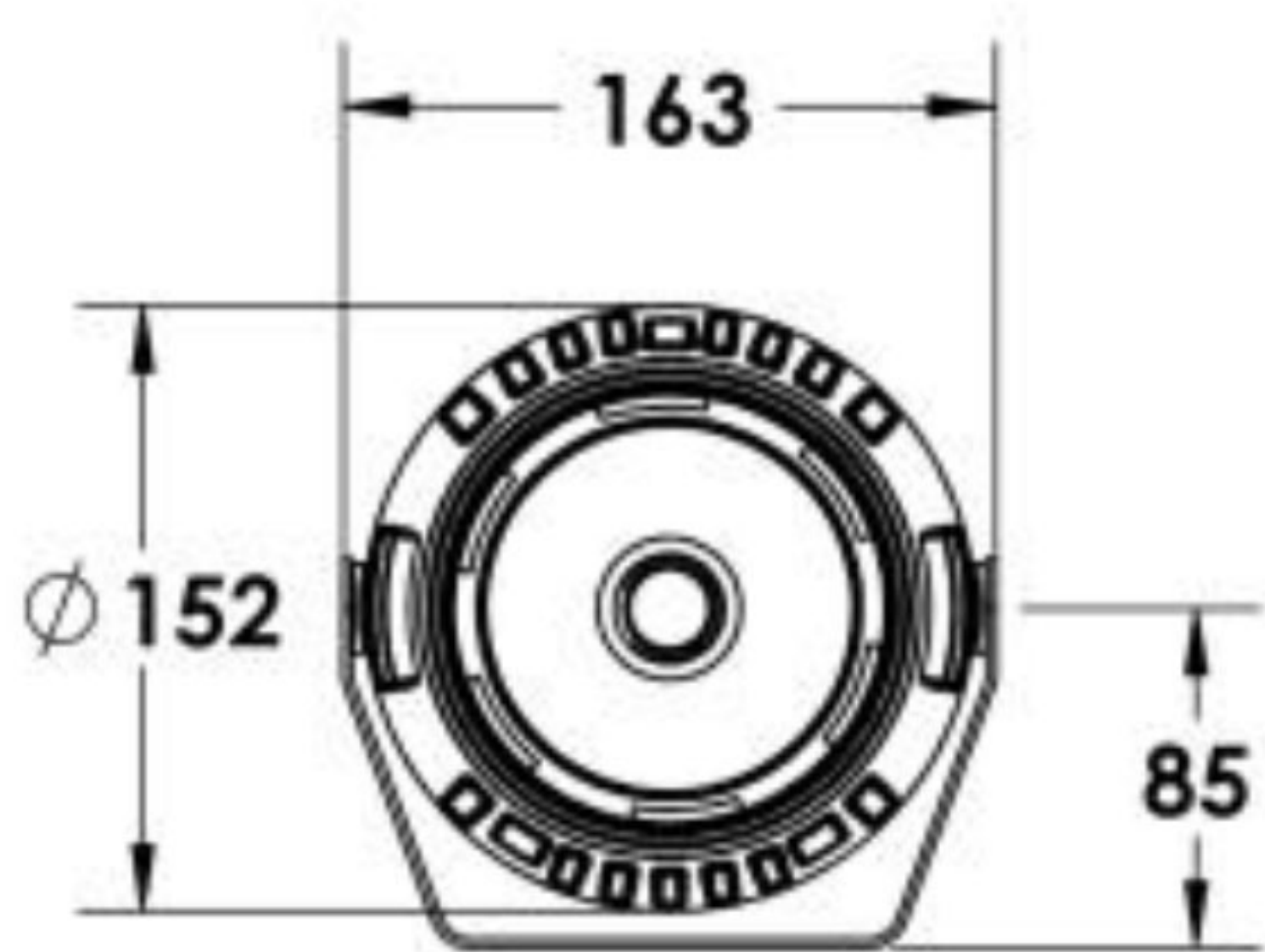

LED Lamp	1
Luminous Flux	1912 lm
Colour temperature	4000K
CRI	80
Nominal Power	14W
Beam Angle	47°

Ingress Protection	IP65
Impact Protection	IK08
Body	Die cast aluminium alloy
Weight	1.6kg
Finish	Power coat finish in white RAL9016, grey RAL9006 or black 9005
Line Voltage	100 ~ 270V / 50-60Hz
Electrical Gear	IP67 LED Driver in a thermally separated compartment

PJL05.4001.47.x.xx

Grünzell®

Mounting Accessories

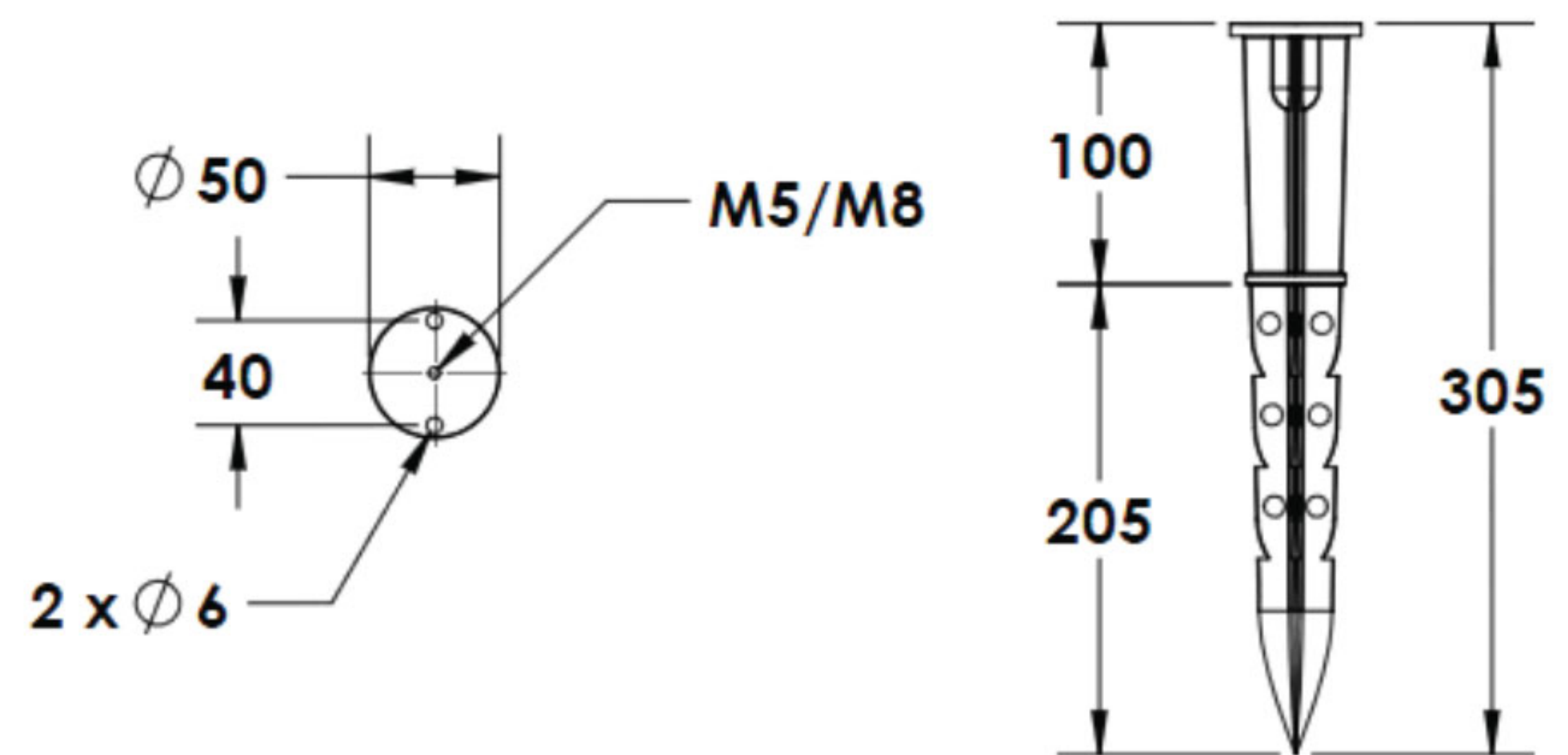

Cast Stirrup
Powder coated die cast aluminium

7210.000.X2.xx

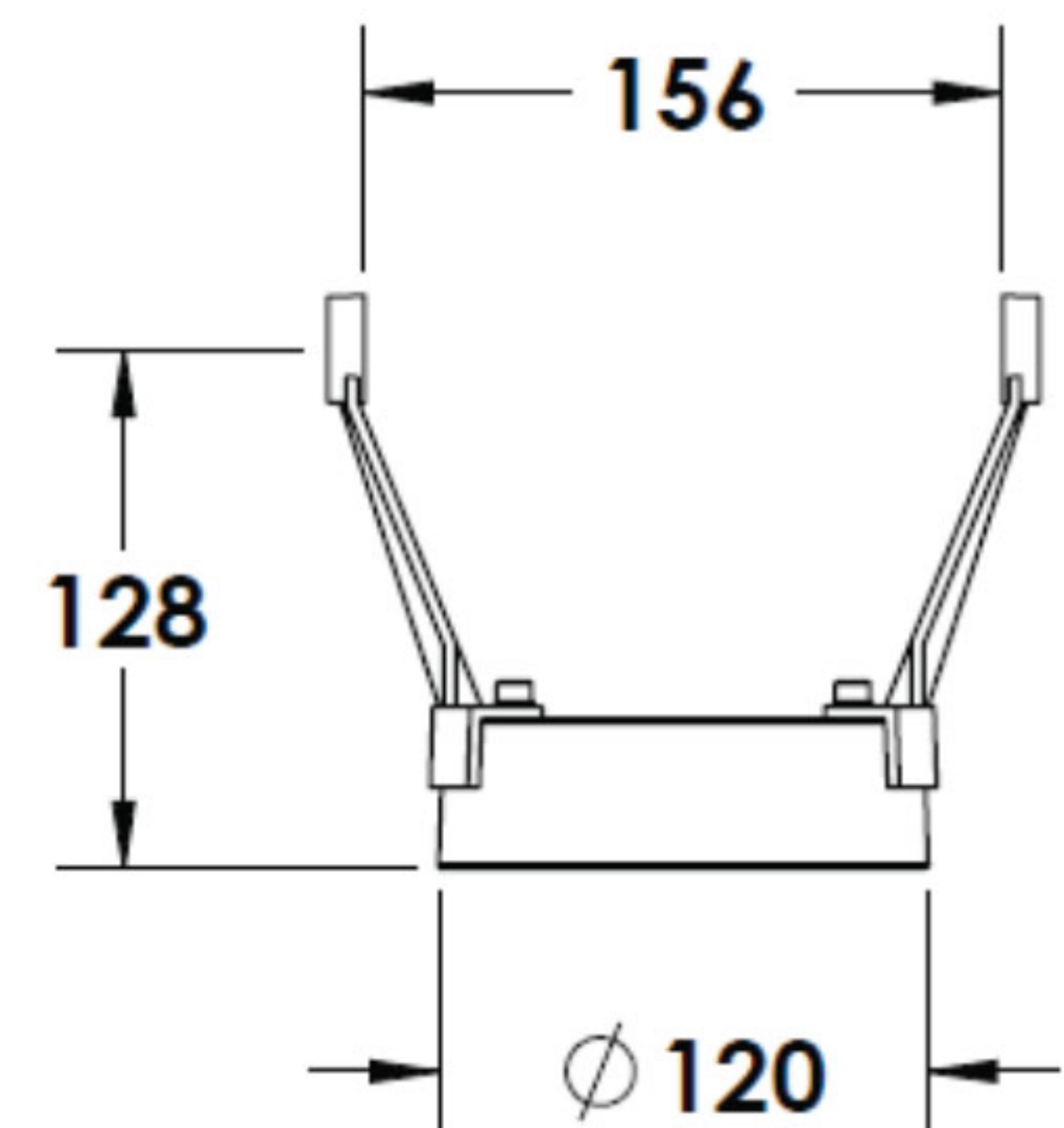

IP65 Gear Base
Powder coated die cast aluminium

P-ACC.C255.GB

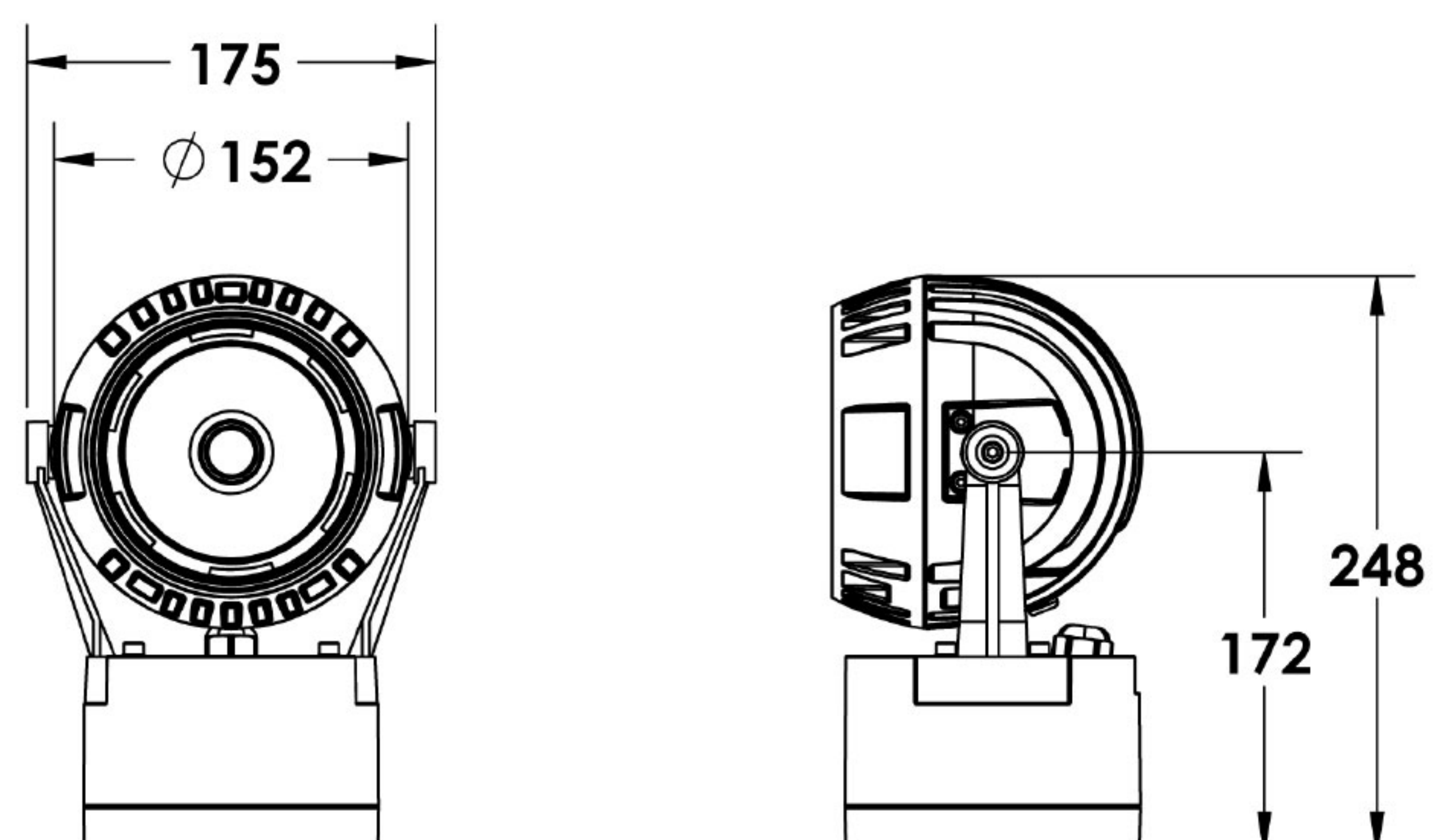

PJL05.4001.47.x.xx

Grünzell®

Optical Accessories

Snoot
Powder coated aluminium

P-ACC.C248.SS

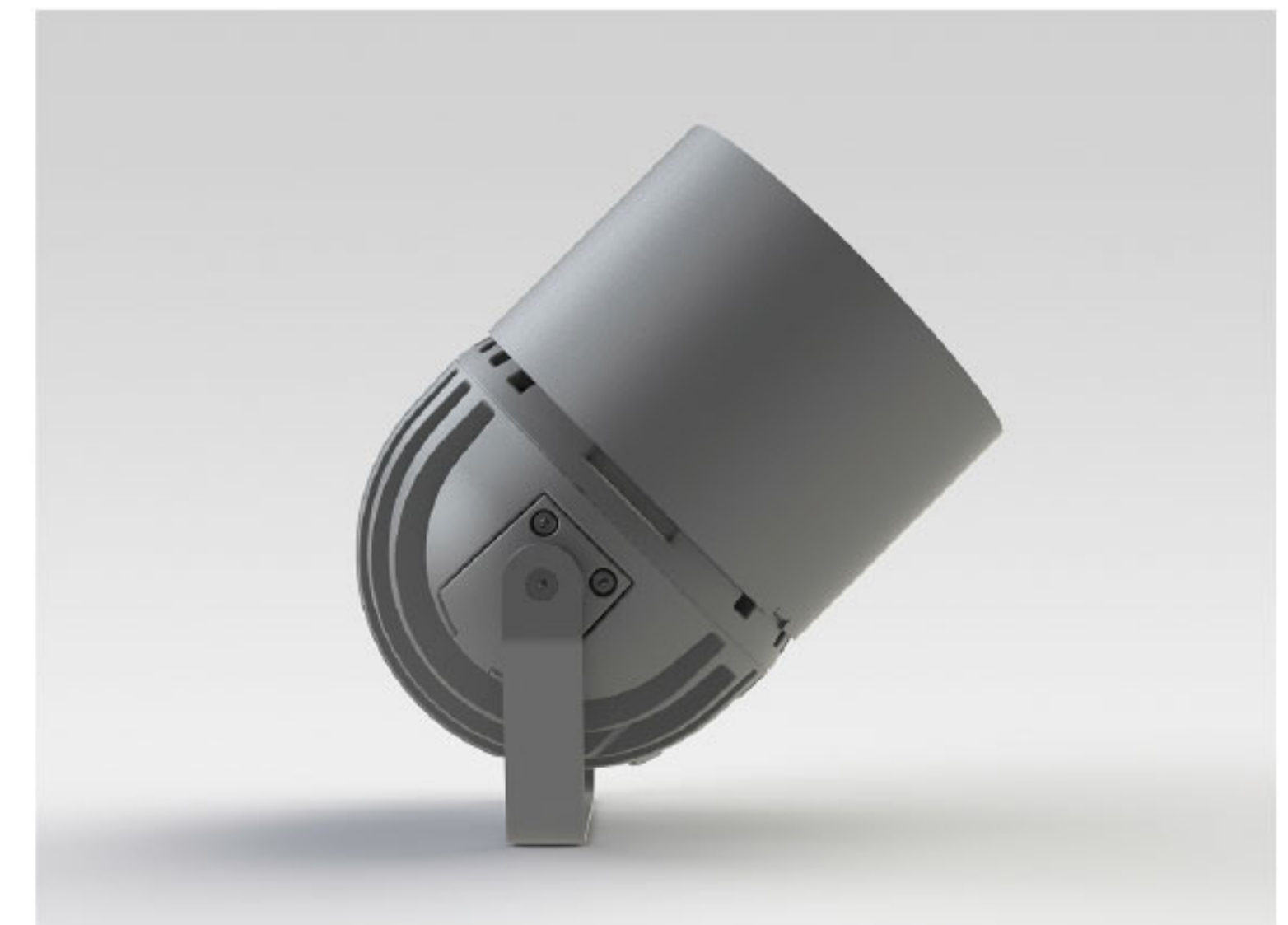
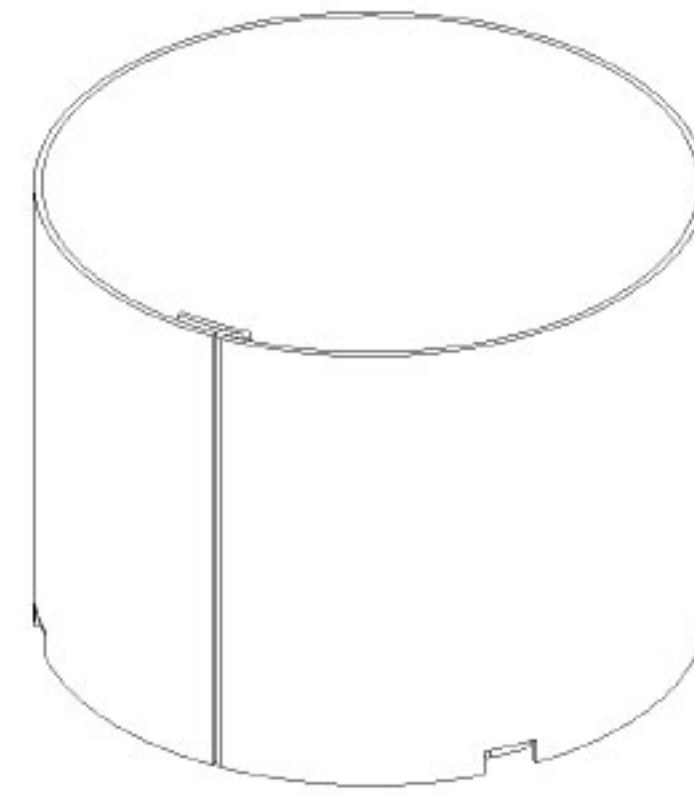

Glare Shield
Powder coated aluminium

P-ACC.C248.GS

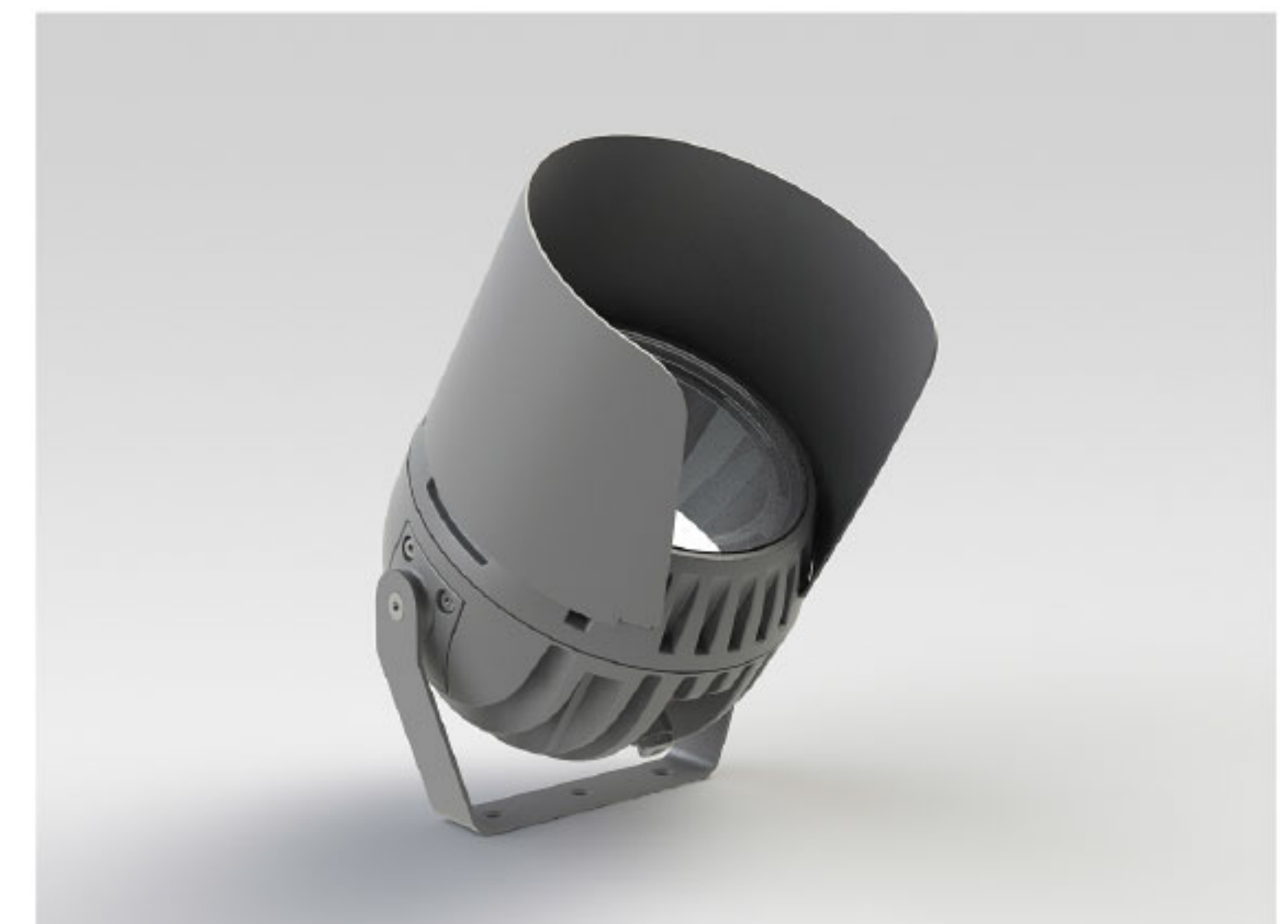
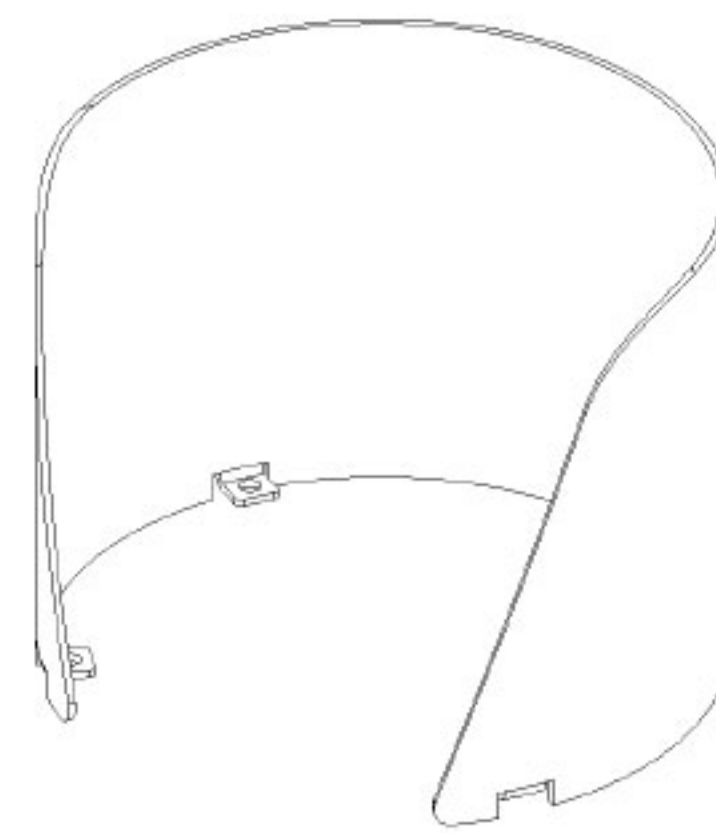

Visor
Powder coated aluminium

P-ACC.C248.VS

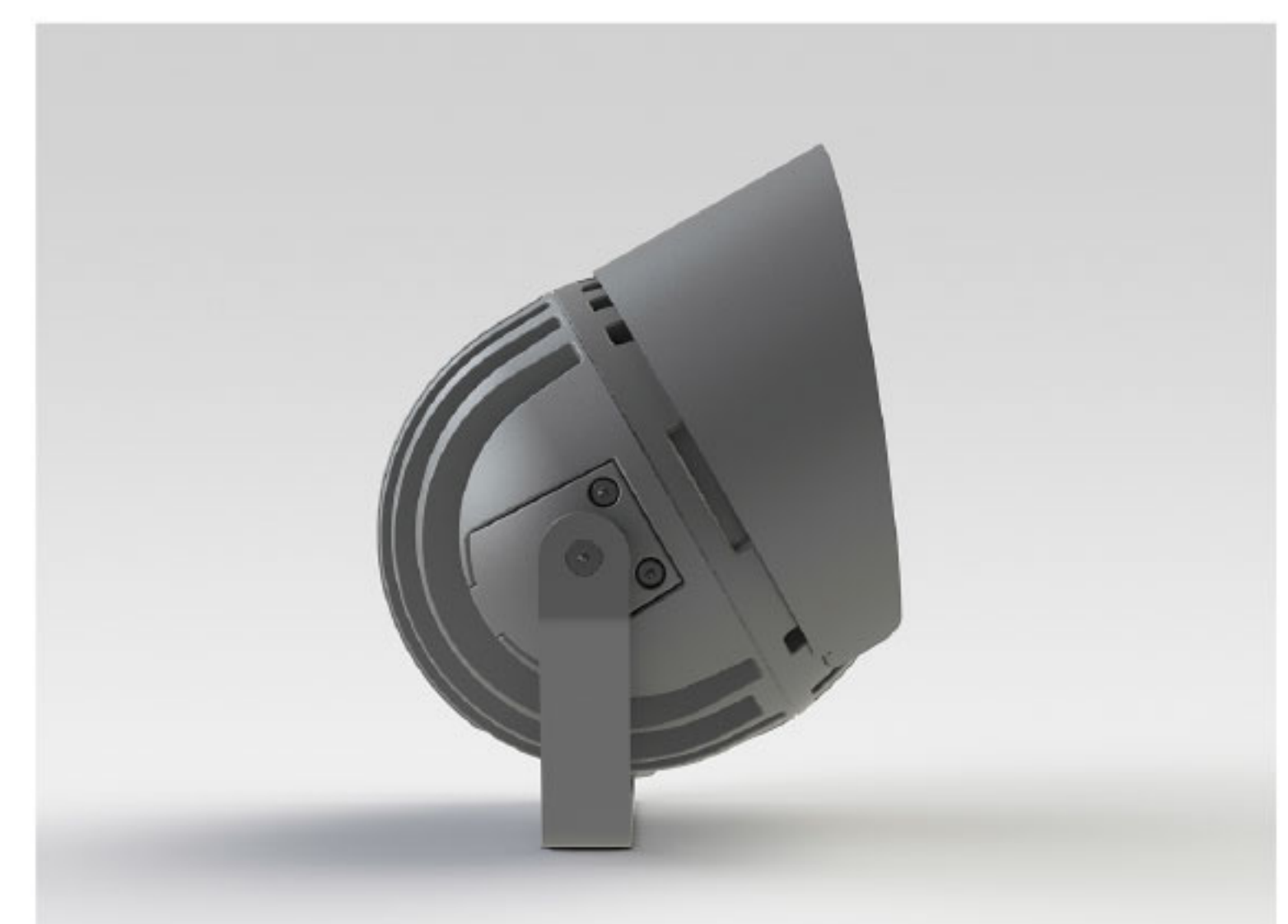
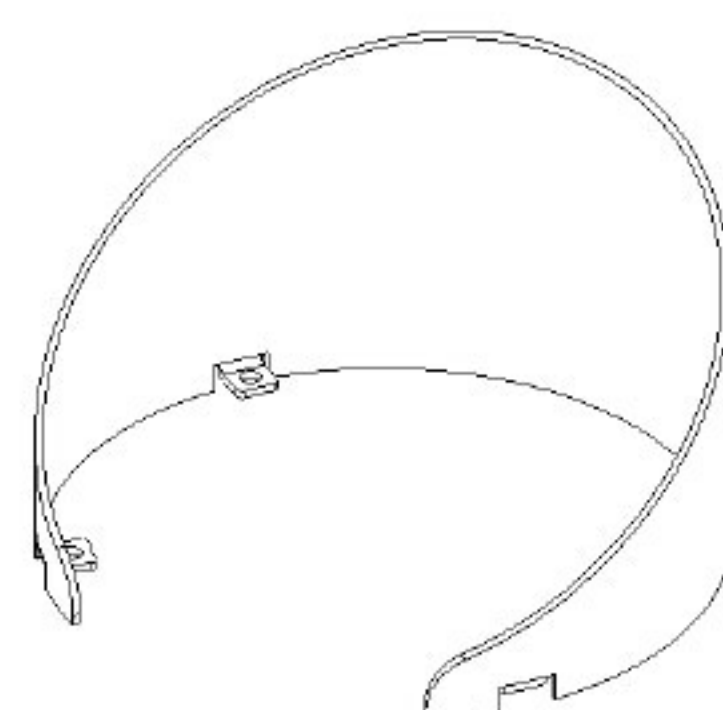

PJL05.4001.47.x.xx



Optical Accessories

Linear Spreading Lens
Tempered Borosilicate Glass

P-ACC.C248.SL

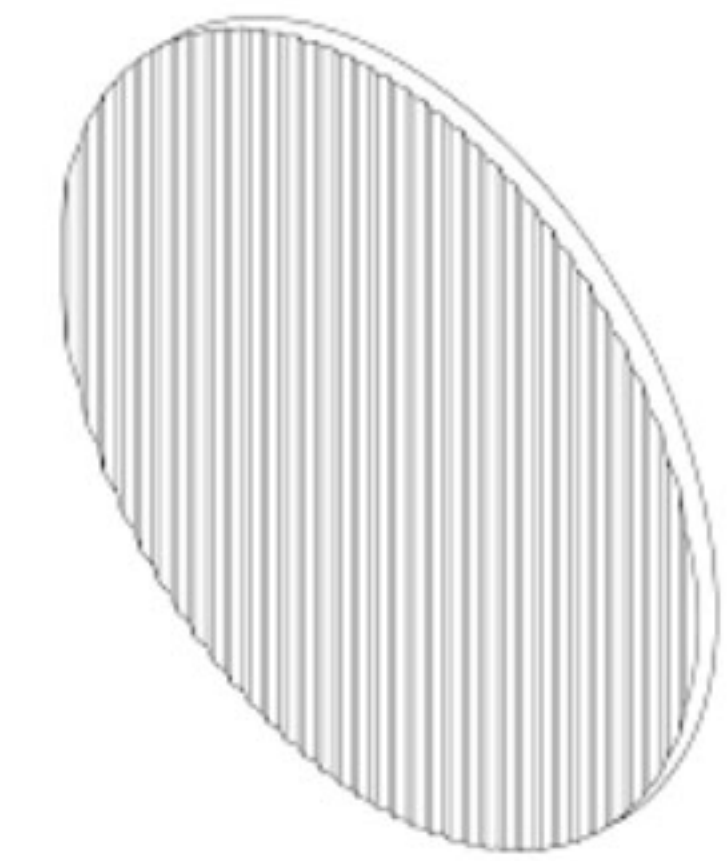

Glass Colour Filter (Red, Green or Blue)
other colour on request

P-ACC.C248.GF



IP65 Driver Box (for remote driver operation)
Powder coated aluminium

P-ACC.xxx.DB.xx

Options -:

1 input, 1 output channel

1 input, 2 output channel

1 input, 3 output channel

