

PJL04.5006.15.x.xx

Grünzell®

Description

IP65 Class I LED Projector with built in LED driver compartment thermally separated in a surface powder coated corrosion resistant die cast aluminium alloy housing. Featured GORE®Vent to protect the internal system from moisture. Silicon rubber gasket and stainless steel 316 screws. Highly specular reflector. Tempered glass cover. COB LED with socket.

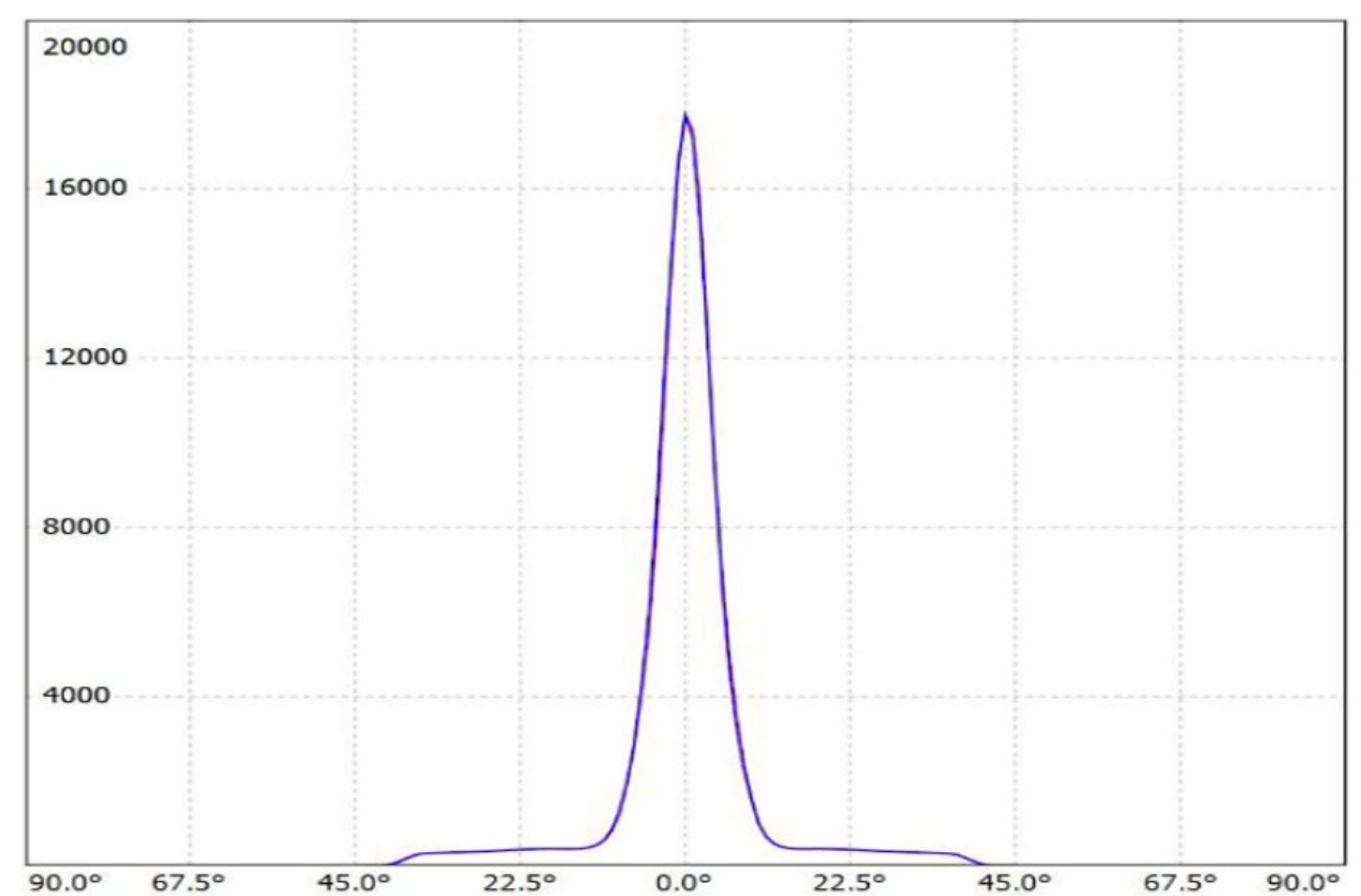
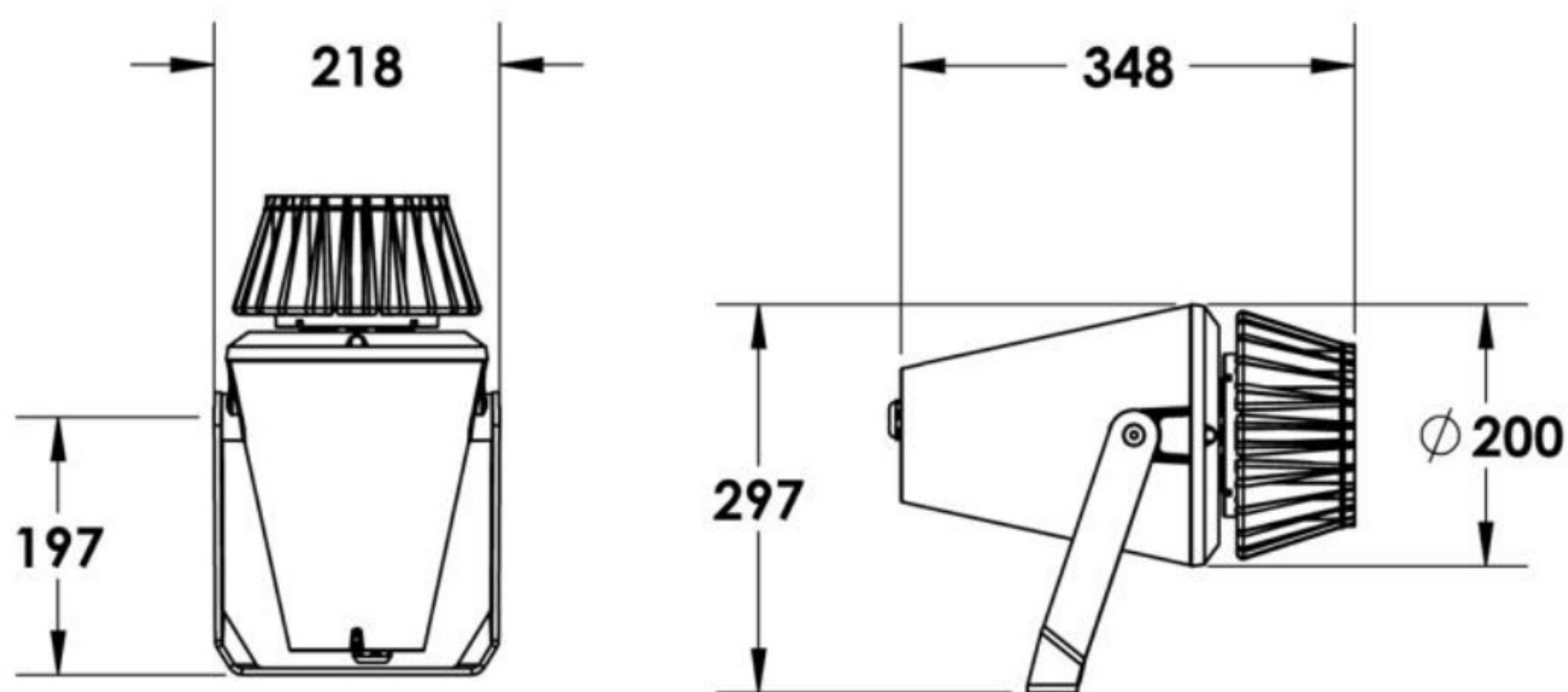

LED Lamp
Luminous Flux
Colour temperature
CRI
Nominal Power
Beam Angle

1
7599 lm
5000K
80
60W
15°

Ingress Protection
Impact Protection
Body
Weight
Finish
Line Voltage
Electrical Gear

IP65
IK08
Die cast aluminium alloy
5.0kg
Power coat finish in white RAL9016, grey RAL9006 or black 9005
100 ~ 270V / 50-60Hz
IP67 LED Driver in a thermally separated compartment

PJL04.5006.15.x.xx



Mounting Accessories

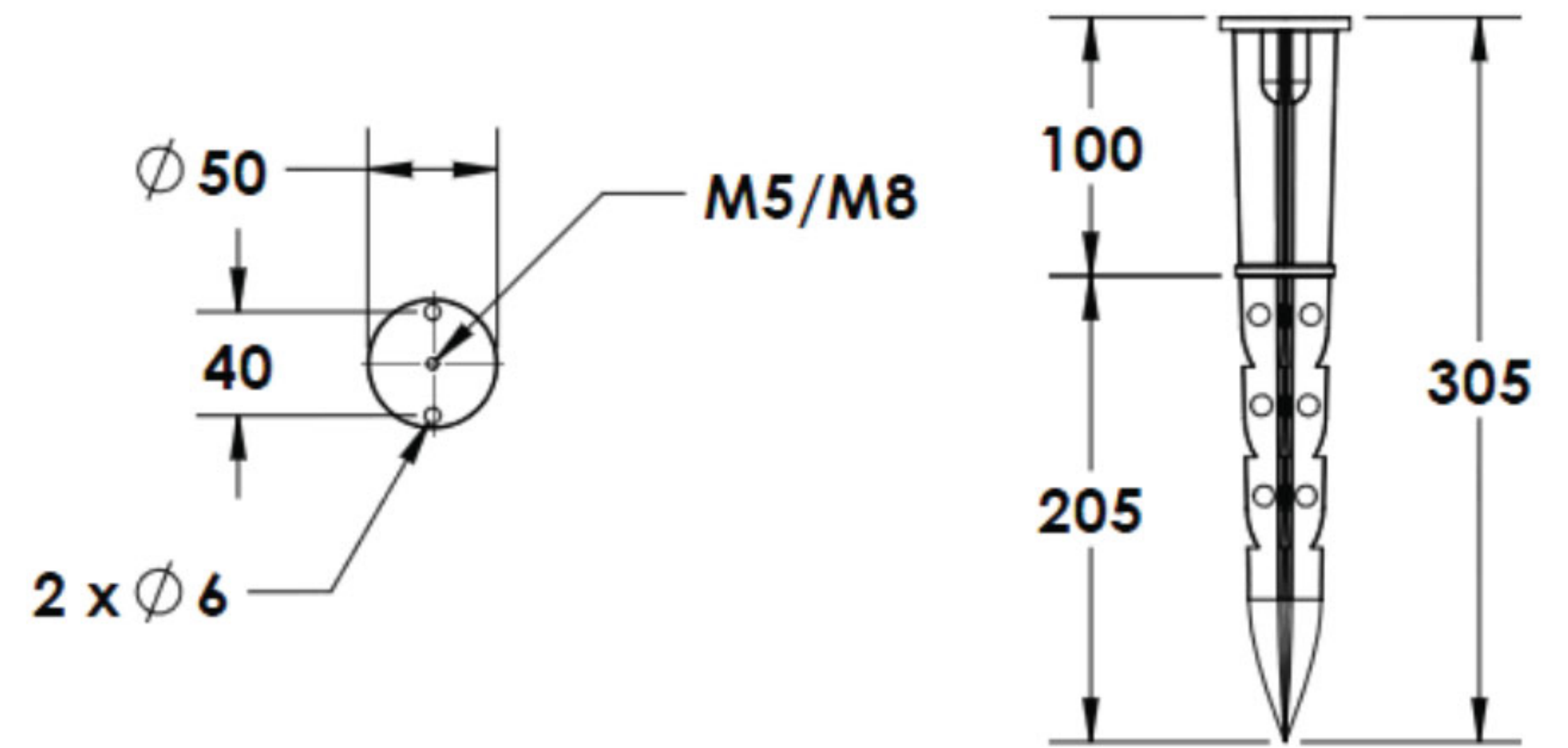

Cast Stirrup
Powder coated die cast aluminium

7210.000.X2.xx

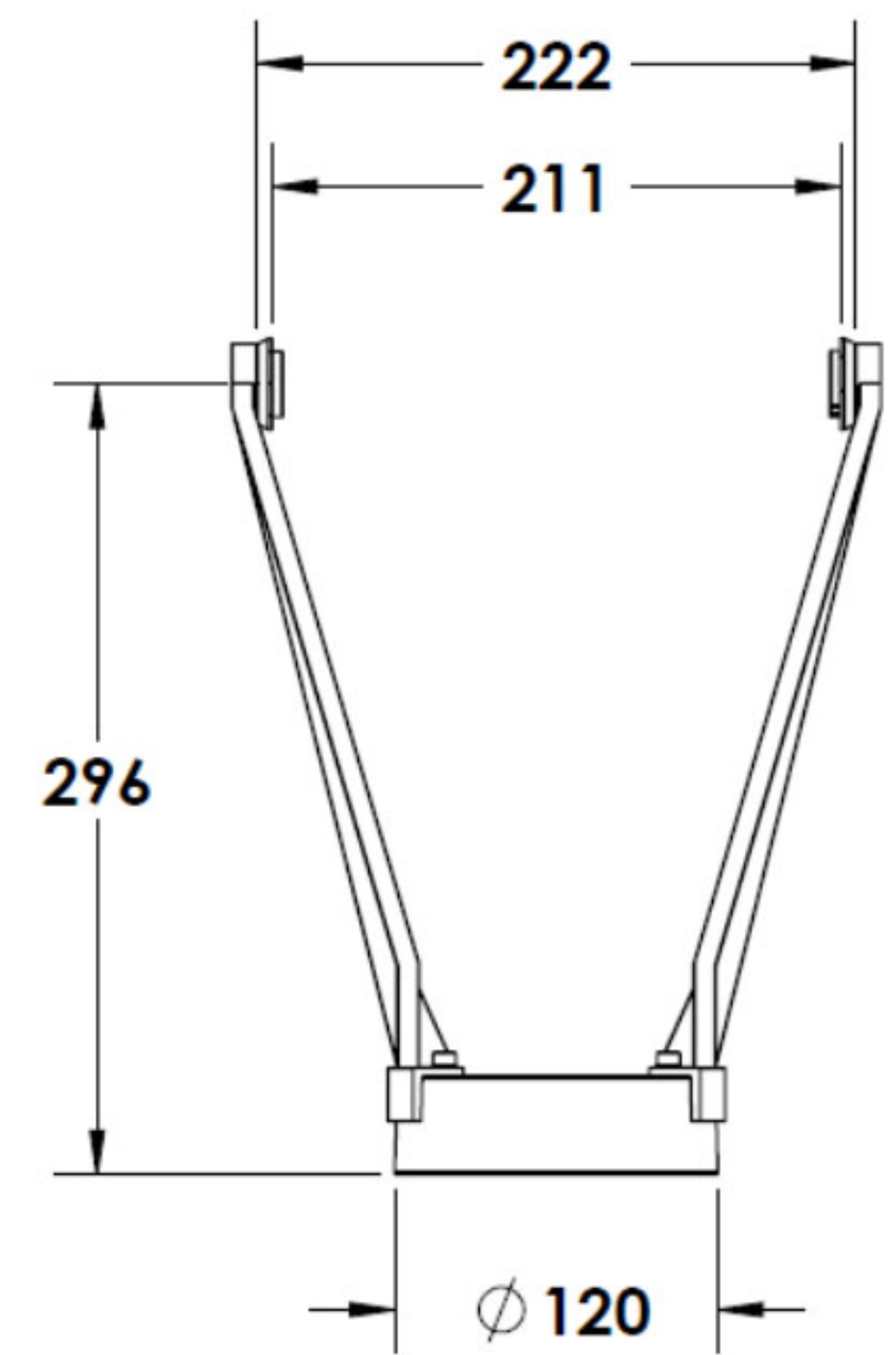

IP65 Gear Base
Powder coated die cast aluminium

P-ACC.C255.GB

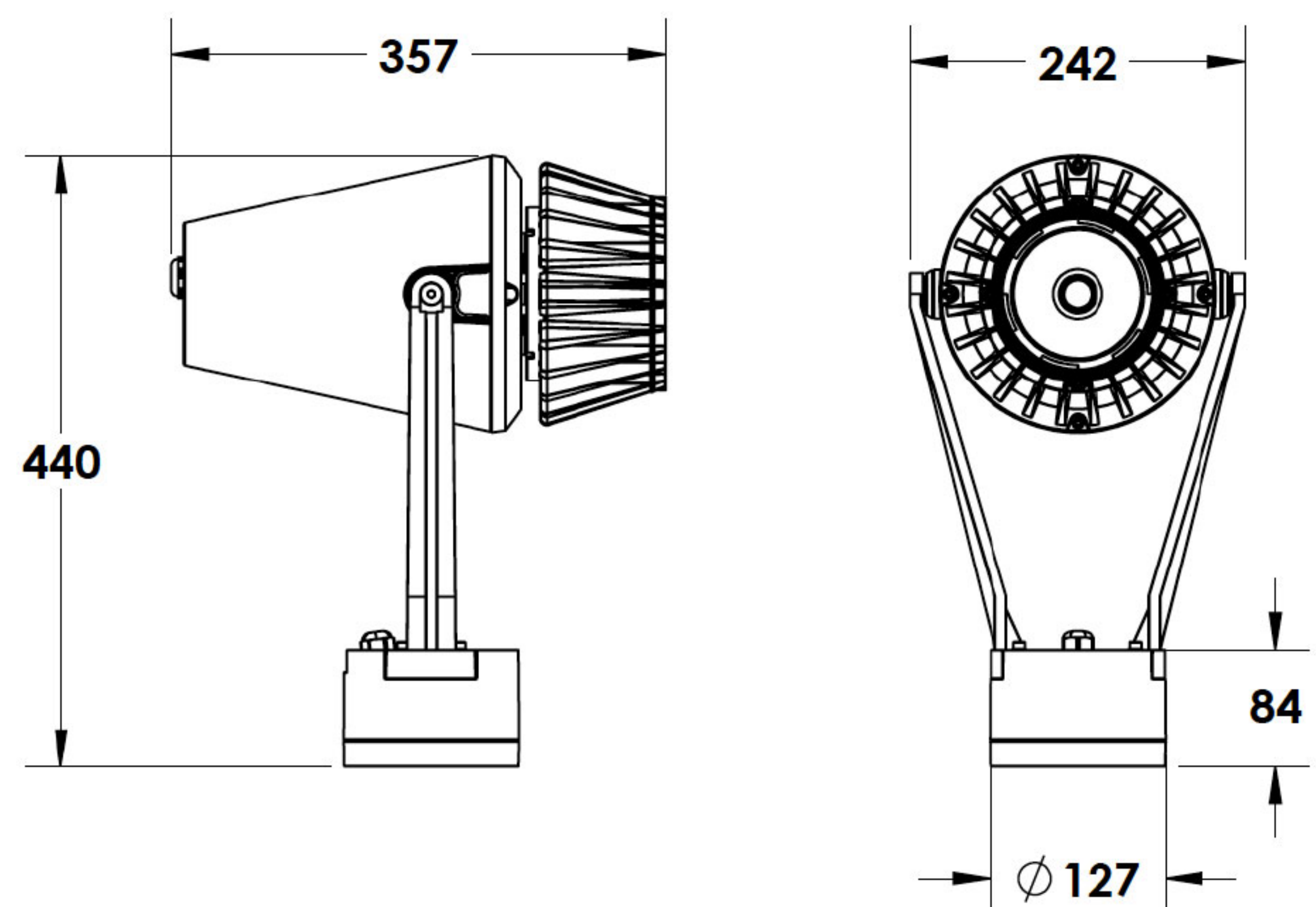

PJL04.5006.15.x.xx



Optical Accessories

Snoot
Powder coated die cast aluminium
P-ACC.C248.SS

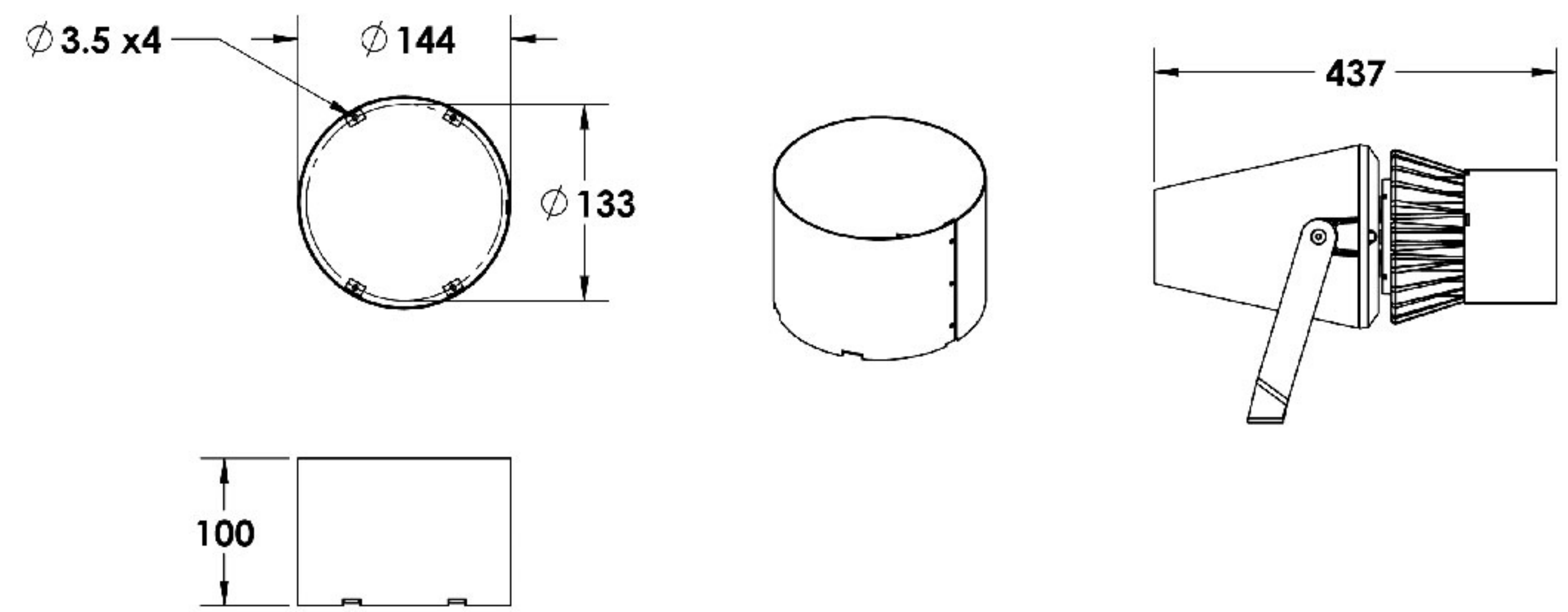

Glare Shield
Powder coated die cast aluminium
P-ACC.C248.GS

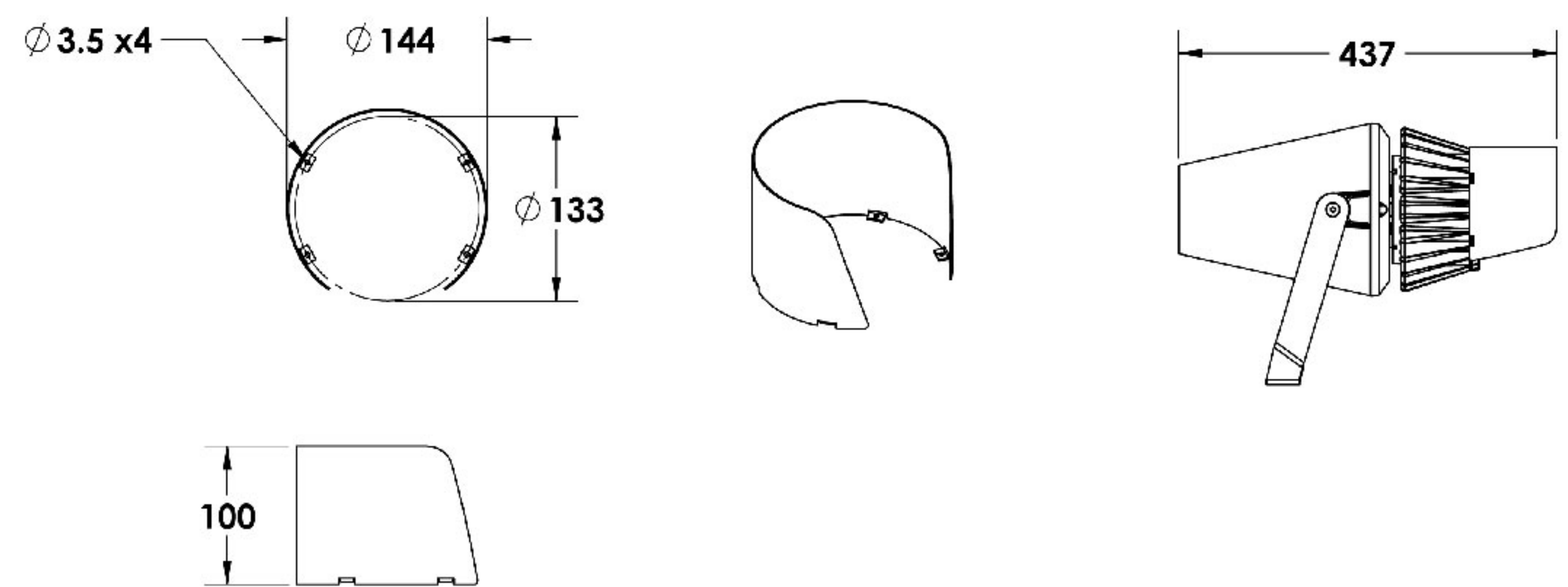

Visor
Powder coated die cast aluminium
P-ACC.C248.VS

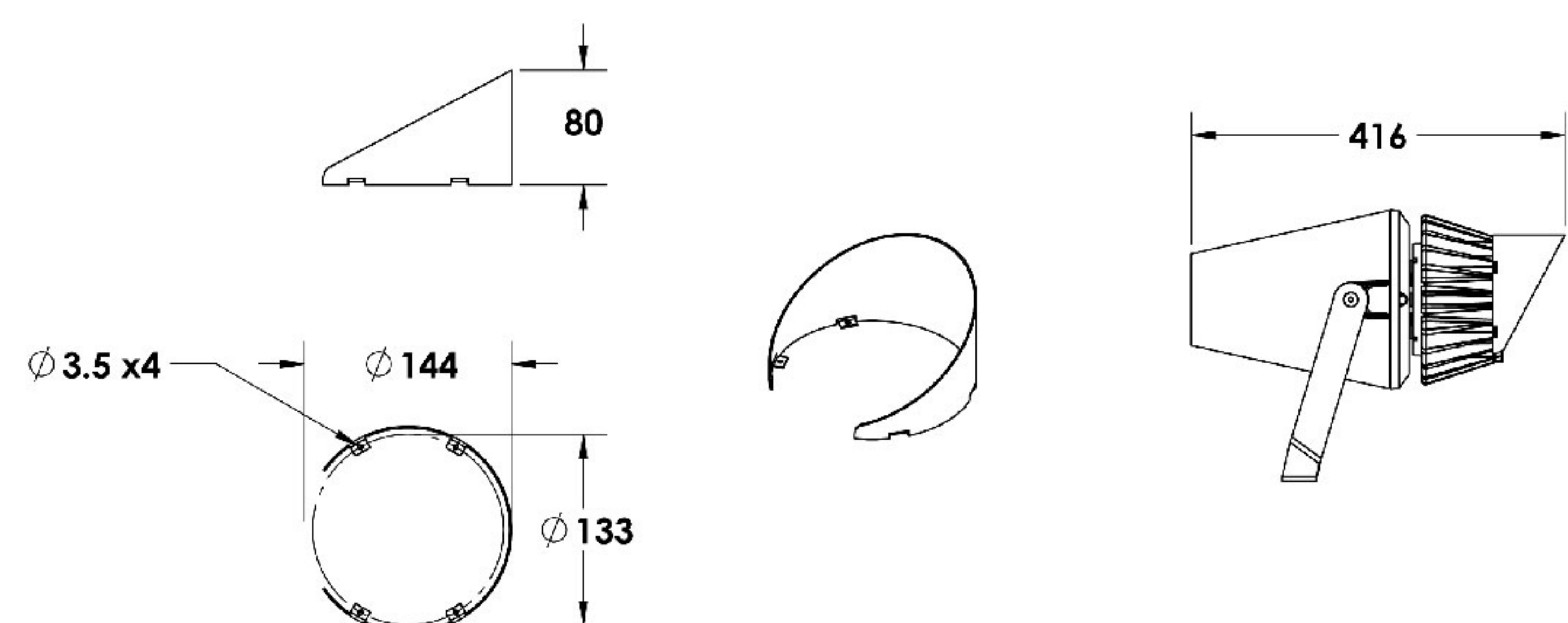

PJL04.5006.15.x.xx



Optical Accessories

Linear Spreading Lens
Tempered Borosilicate Glass

P-ACC.C248.SL

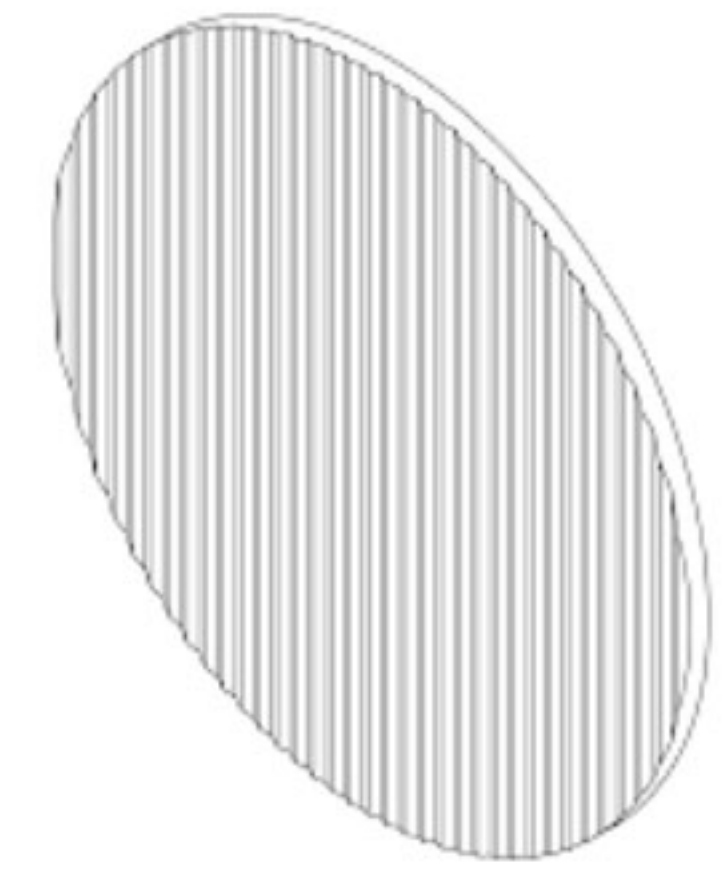

Glass Colour Filter (Red, Green or Blue)
other colour on request

P-ACC.C248.GF

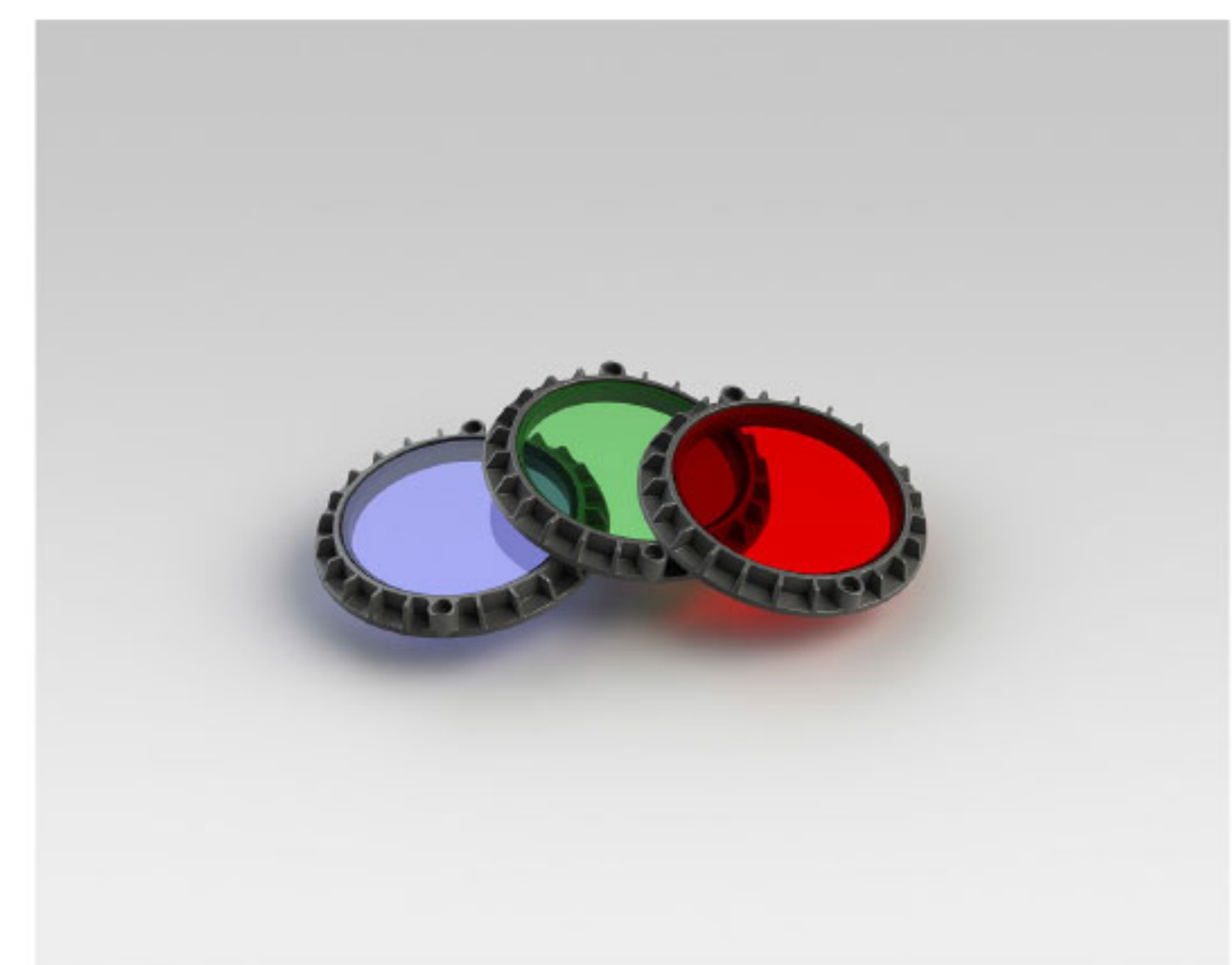

IP65 Driver Box (for remote driver operation)
Powder coated aluminium

P-ACC.xxx.DB.xx

Options -:

1 input, 1 output channel

1 input, 2 output channel

1 input, 3 output channel

