

# PJL04.2706.15.x.xx

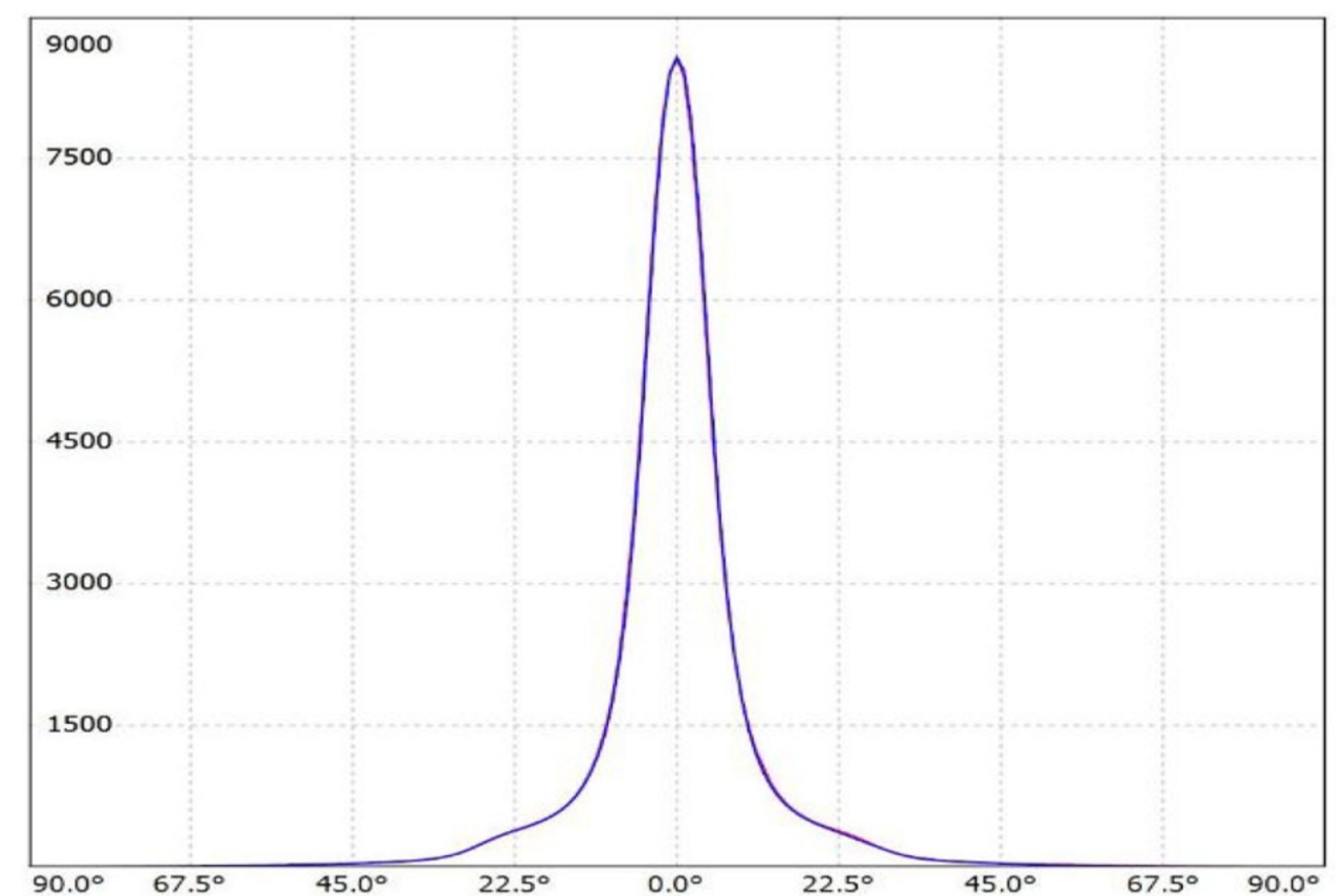

## Description

IP65 Class I LED Projector with built in LED driver compartment thermally separated in a surface powder coated corrosion resistant die cast aluminium alloy housing. Featured GORE®Vent to protect the internal system from moisture. Silicon rubber gasket and stainless steel 316 screws. Highly specular reflector. Tempered glass cover. COB LED with socket.

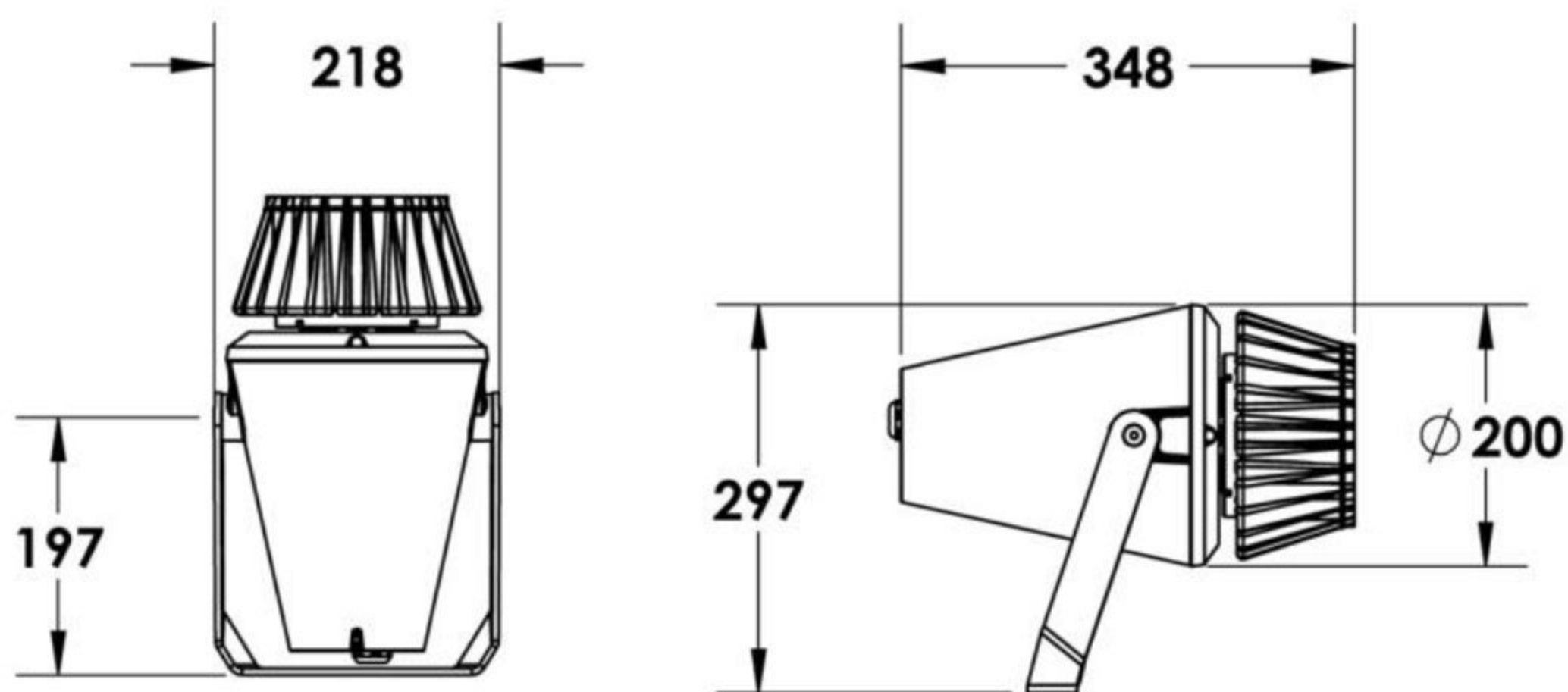

**LED Lamp**  
**Luminous Flux**  
**Colour temperature**  
**CRI**  
**Nominal Power**  
**Beam Angle**

1  
9576 lm  
2700K  
80  
80W  
15°

**Ingress Protection**  
**Impact Protection**  
**Body**  
**Weight**  
**Finish**  
**Line Voltage**  
**Electrical Gear**

IP65  
IK08  
Die cast aluminium alloy  
5.0kg  
Power coat finish in white RAL9016, grey RAL9006 or black 9005  
100 ~ 270V / 50-60Hz  
IP67 LED Driver in a thermally separated compartment

# PJL04.2706.15.x.xx



## Mounting Accessories

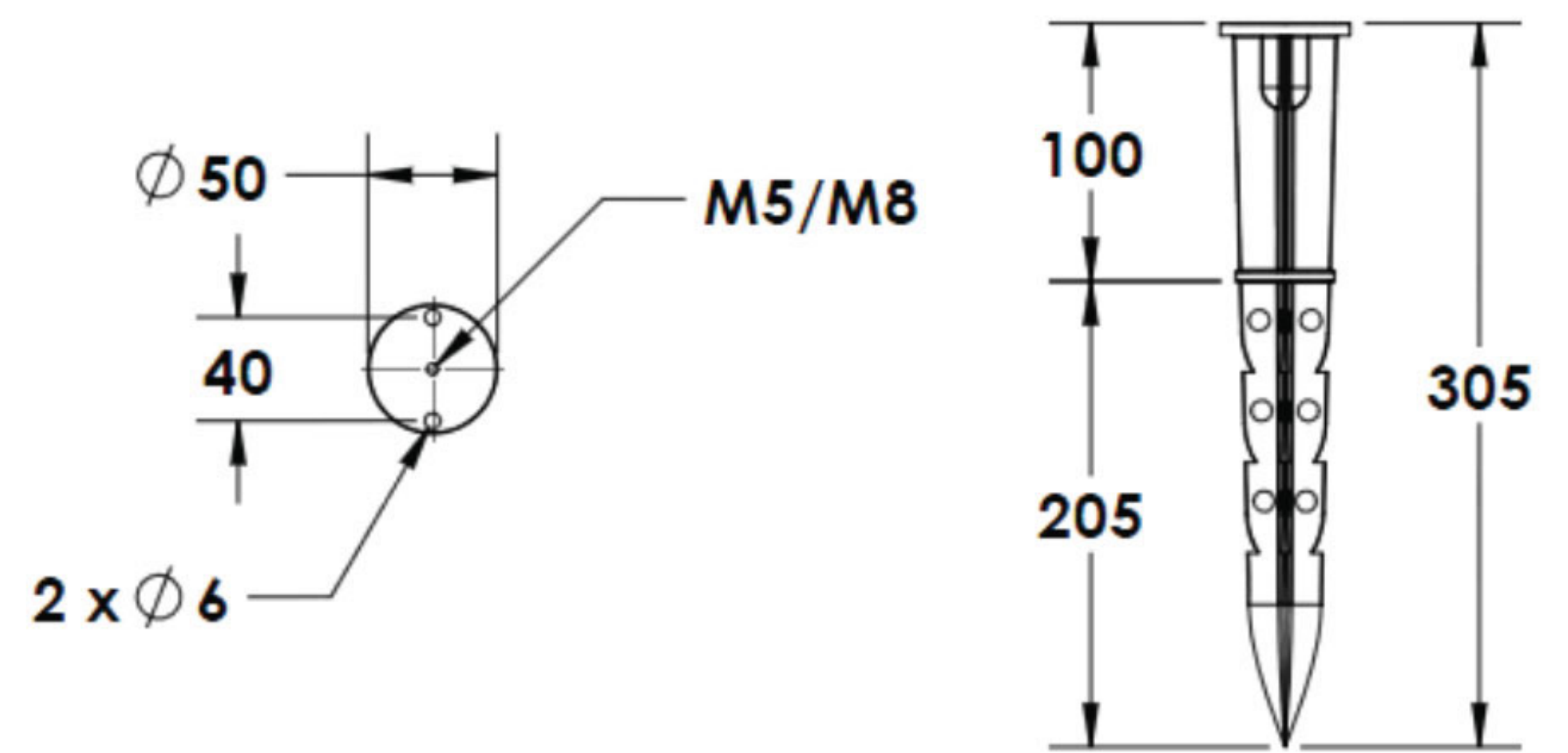

Cast Stirrup  
Powder coated die cast aluminium

7210.000.X2.xx

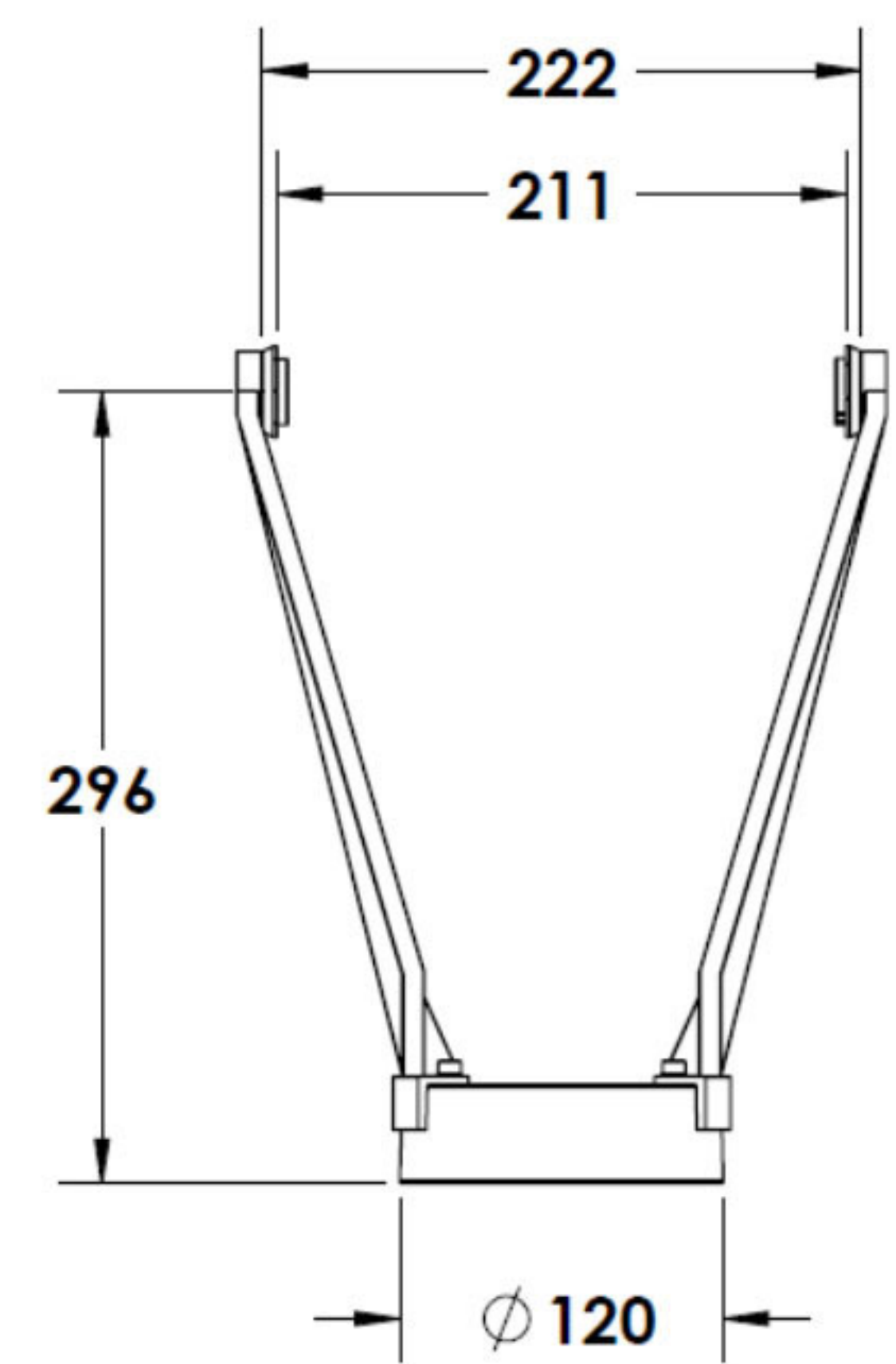

IP65 Gear Base  
Powder coated die cast aluminium

P-ACC.C255.GB

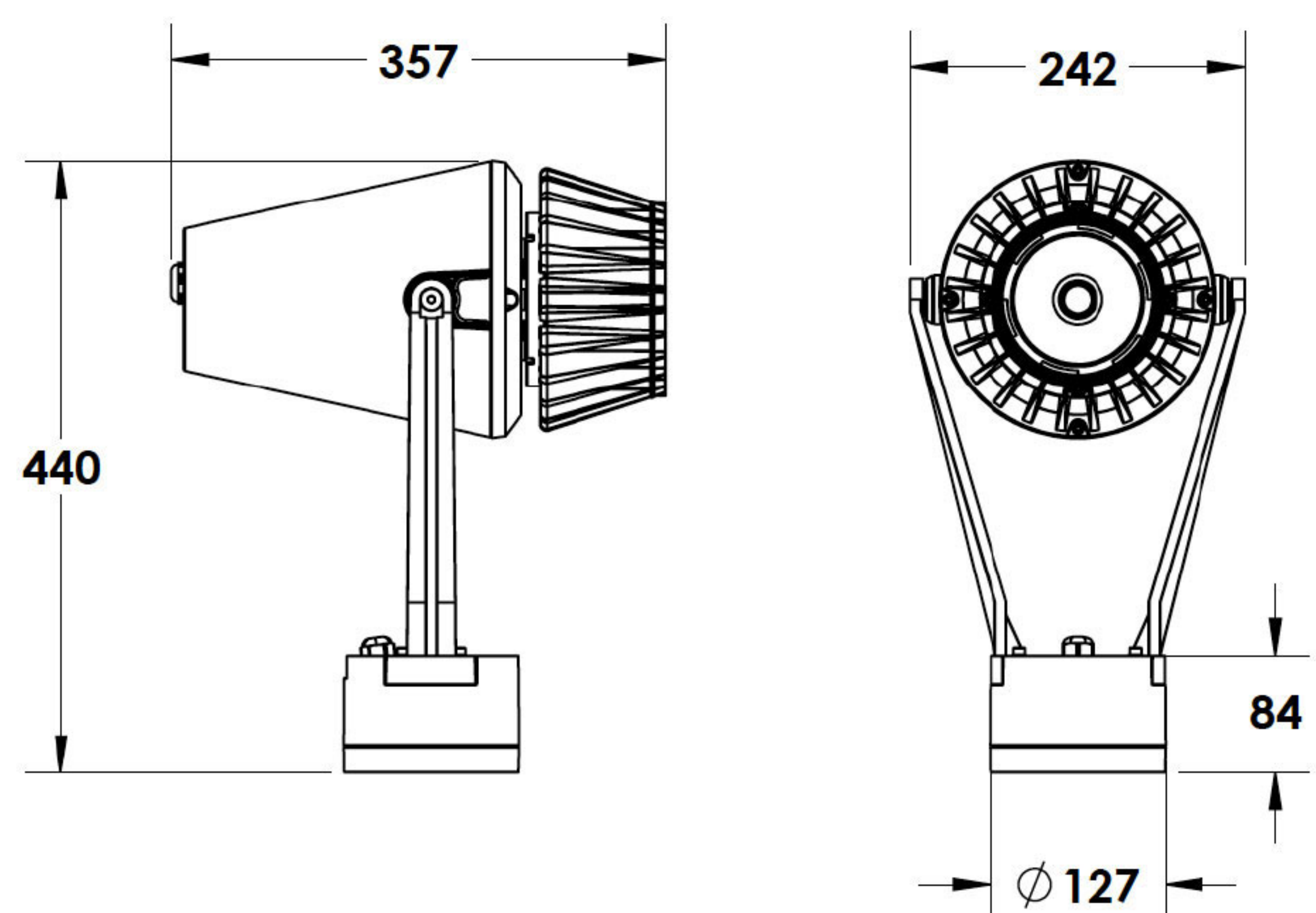

# PJL04.2706.15.x.xx

# Grünzell®

## Optical Accessories

Snoot  
Powder coated die cast aluminium

P-ACC.C248.SS

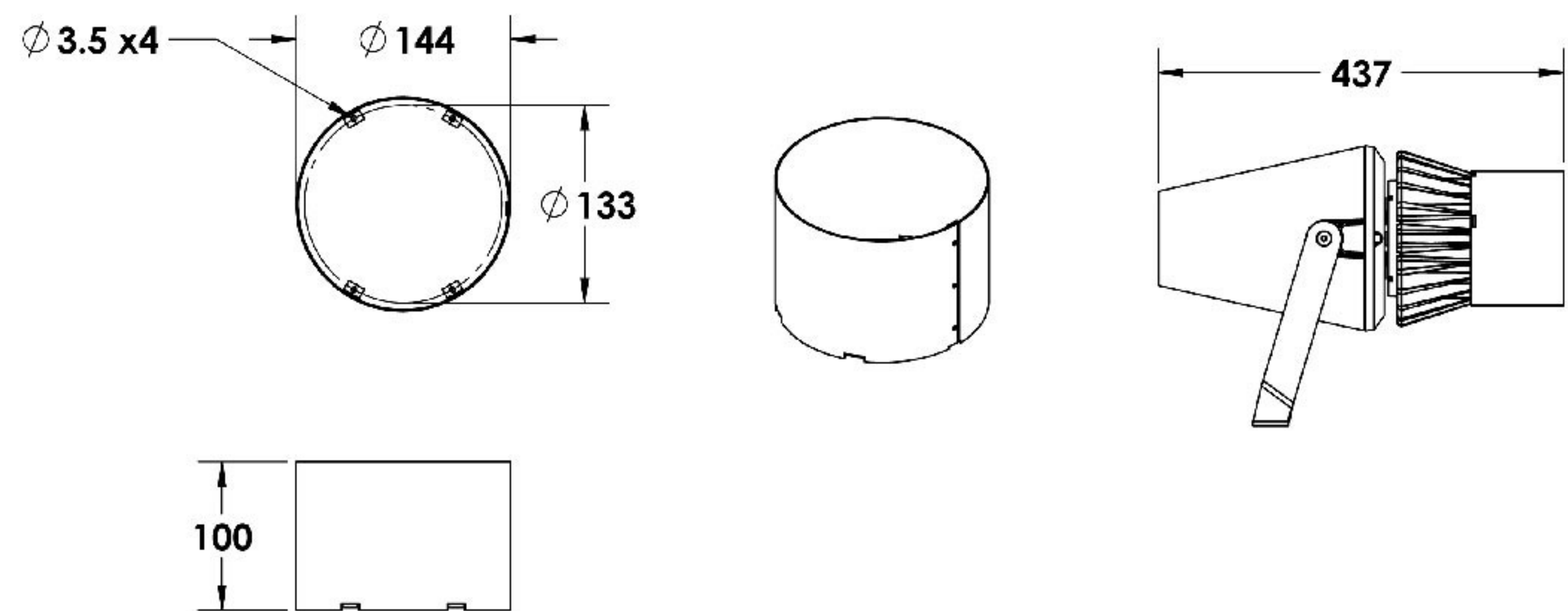

Glare Shield  
Powder coated die cast aluminium

P-ACC.C248.GS

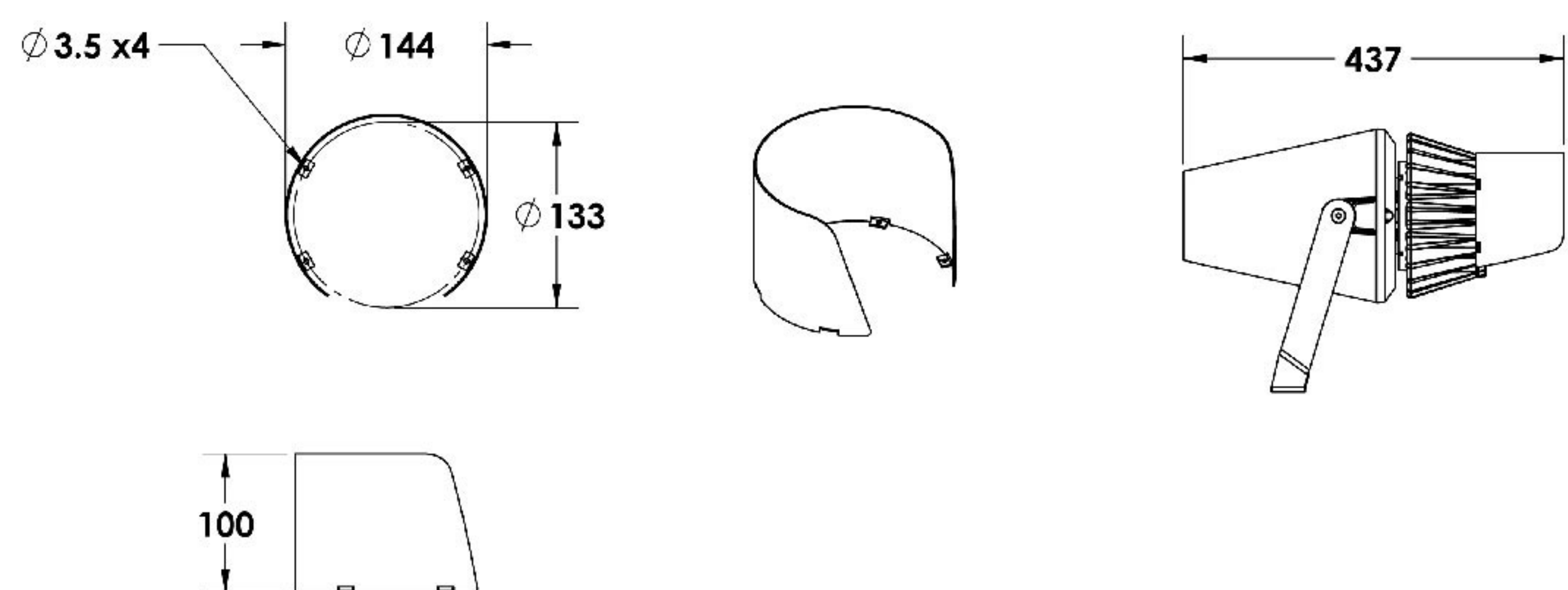

Visor  
Powder coated die cast aluminium

P-ACC.C248.VS

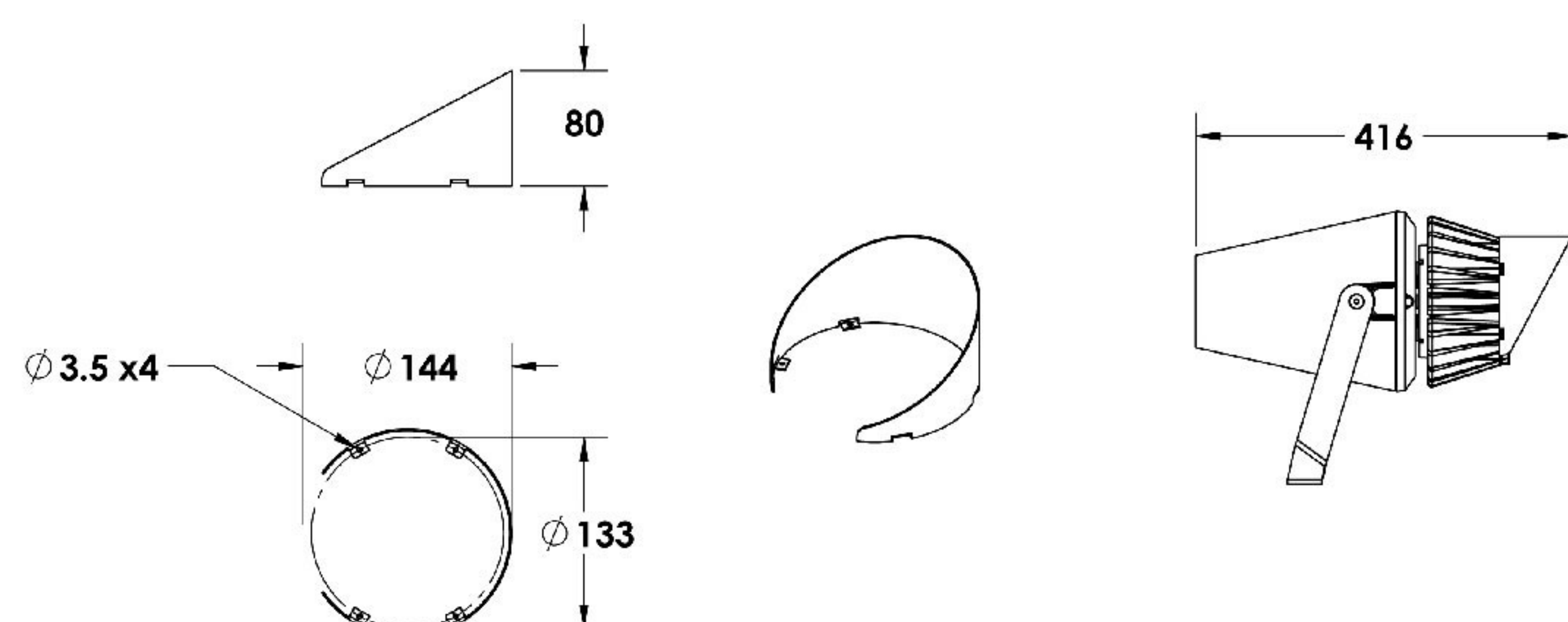

# PJL04.2706.15.x.xx



## Optical Accessories

Linear Spreading Lens  
Tempered Borosilicate Glass

P-ACC.C248.SL

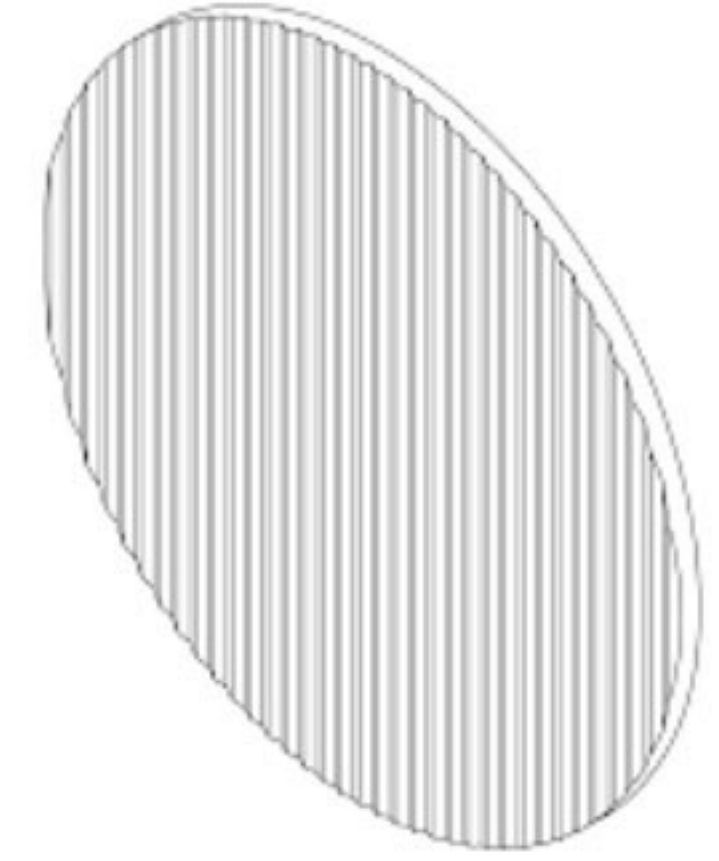

Glass Colour Filter (Red, Green or Blue)  
other colour on request

P-ACC.C248.GF



IP65 Driver Box (for remote driver operation)  
Powder coated aluminium

P-ACC.xxx.DB.xx

Options -:

1 input, 1 output channel

1 input, 2 output channel

1 input, 3 output channel

