

PJL03.2704.26.x.xx

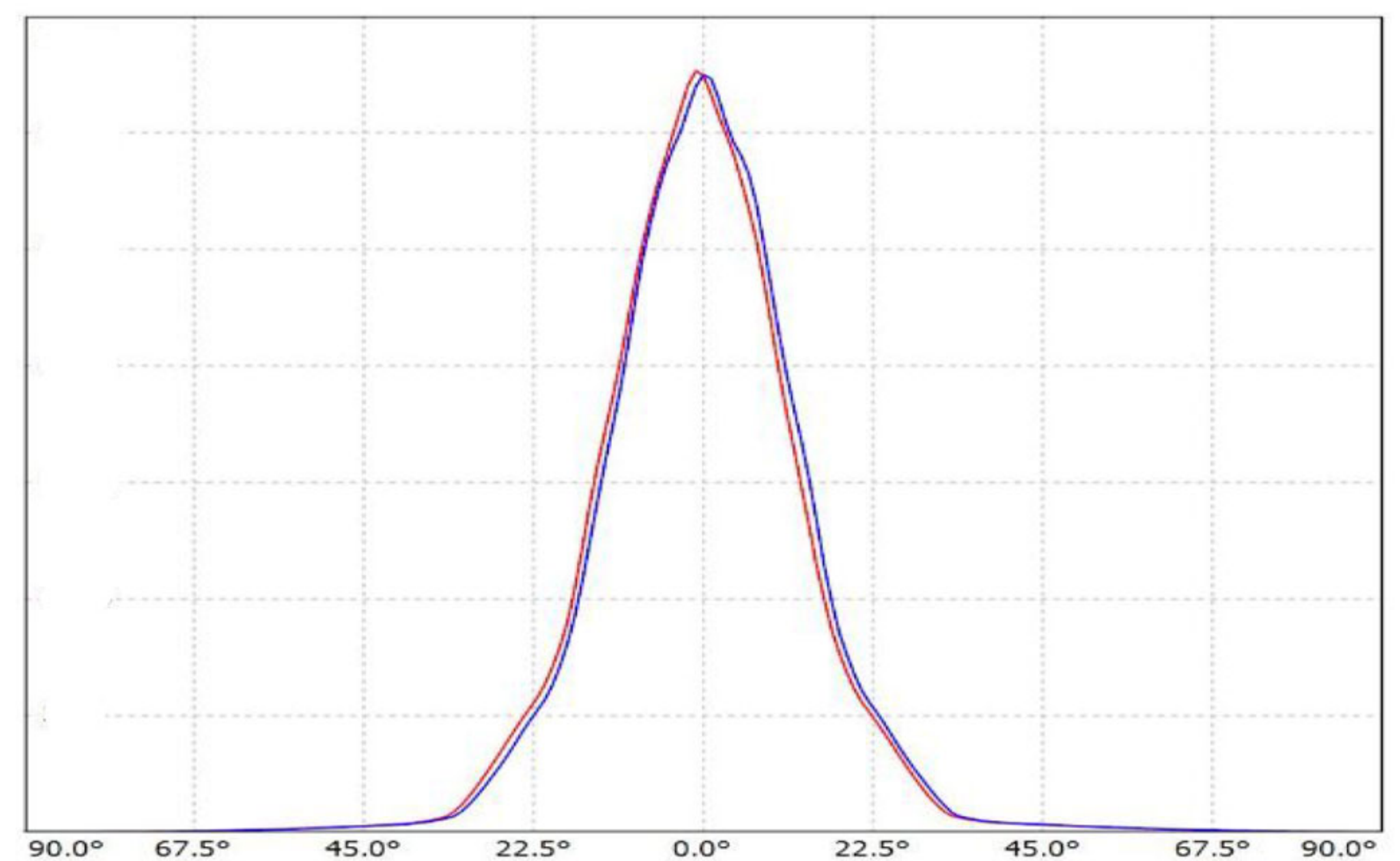

Description

IP65 Class I LED Projector with built in LED driver compartment thermally separated in a surface powder coated corrosion resistant die cast aluminium alloy housing. Featured GORE®Vent to protect the internal system from moisture. Silicon rubber gasket and stainless steel 316 screws. Highly specular reflector. Tempered glass cover. COB LED with socket.

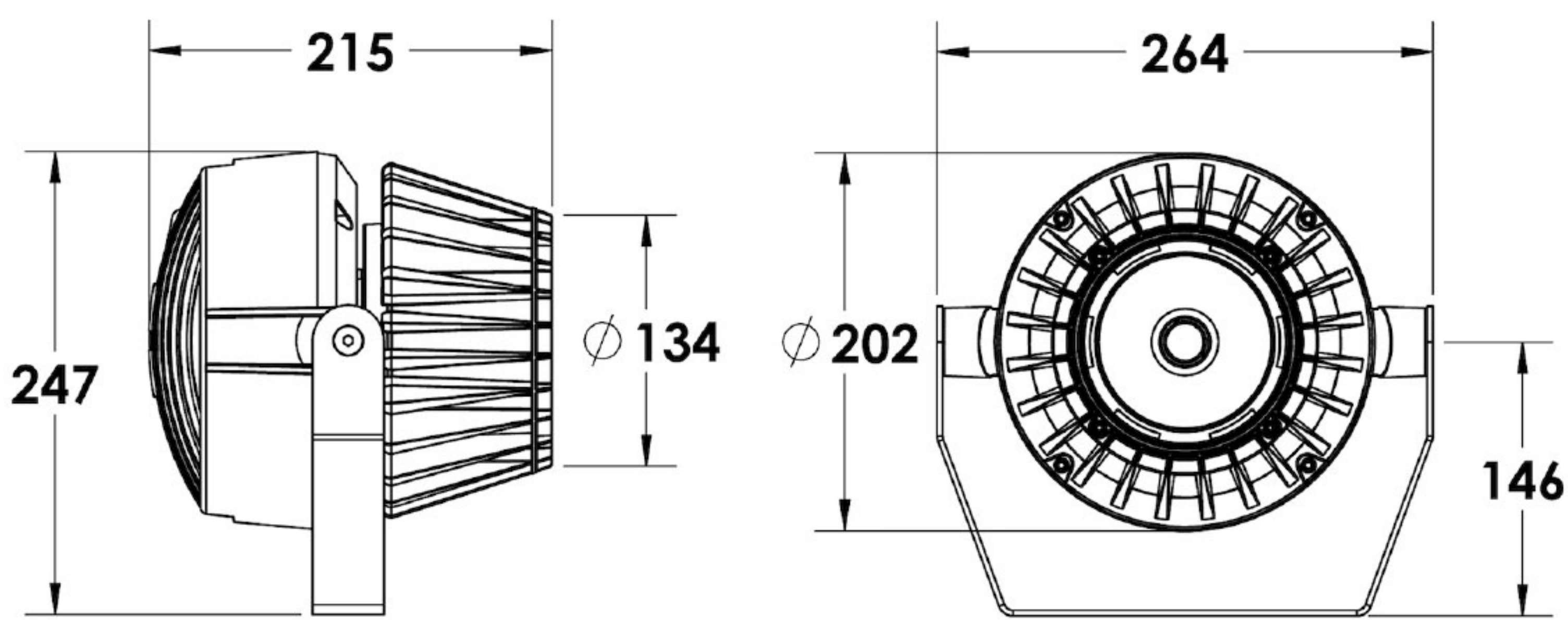

LED Lamp	1
Luminous Flux	5107 lm
Colour temperature	2700K
CRI	80
Nominal Power	35W
Beam Angle	26°

Ingress Protection	IP65
Impact Protection	IK08
Body	Die cast aluminium alloy
Weight	4.2kg
Finish	Power coat finish in white RAL9016, grey RAL9006 or black 9005
Line Voltage	100 ~ 270V / 50-60Hz
Electrical Gear	IP67 LED Driver in a thermally separated compartment

PJL03.2704.26.x.xx



Mounting Accessories

Ground Spike
Powder coated die cast aluminium

7228.005.01.02

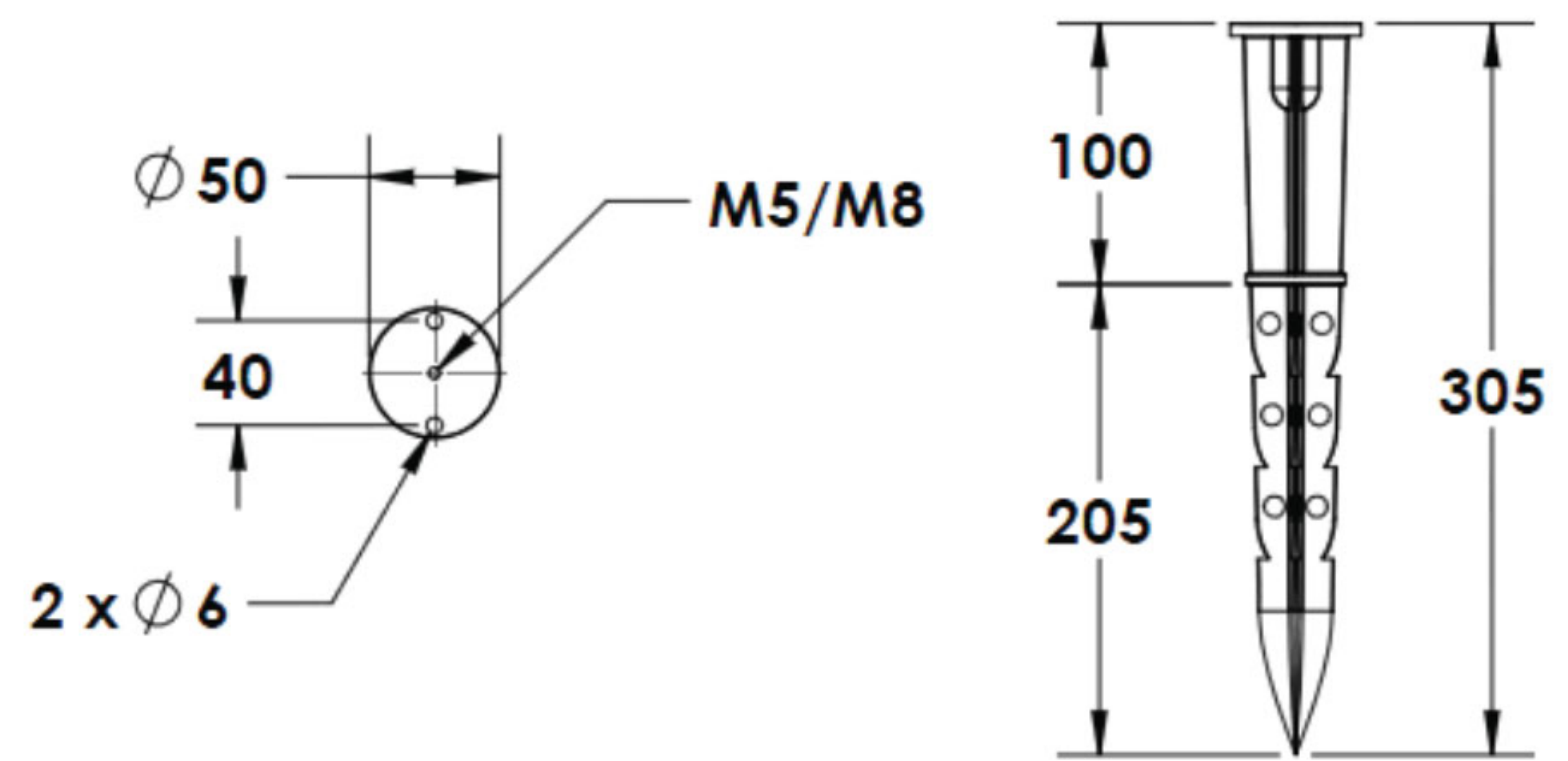

Cast Stirrup
Powder coated die cast aluminium

7220.000.X2.xx

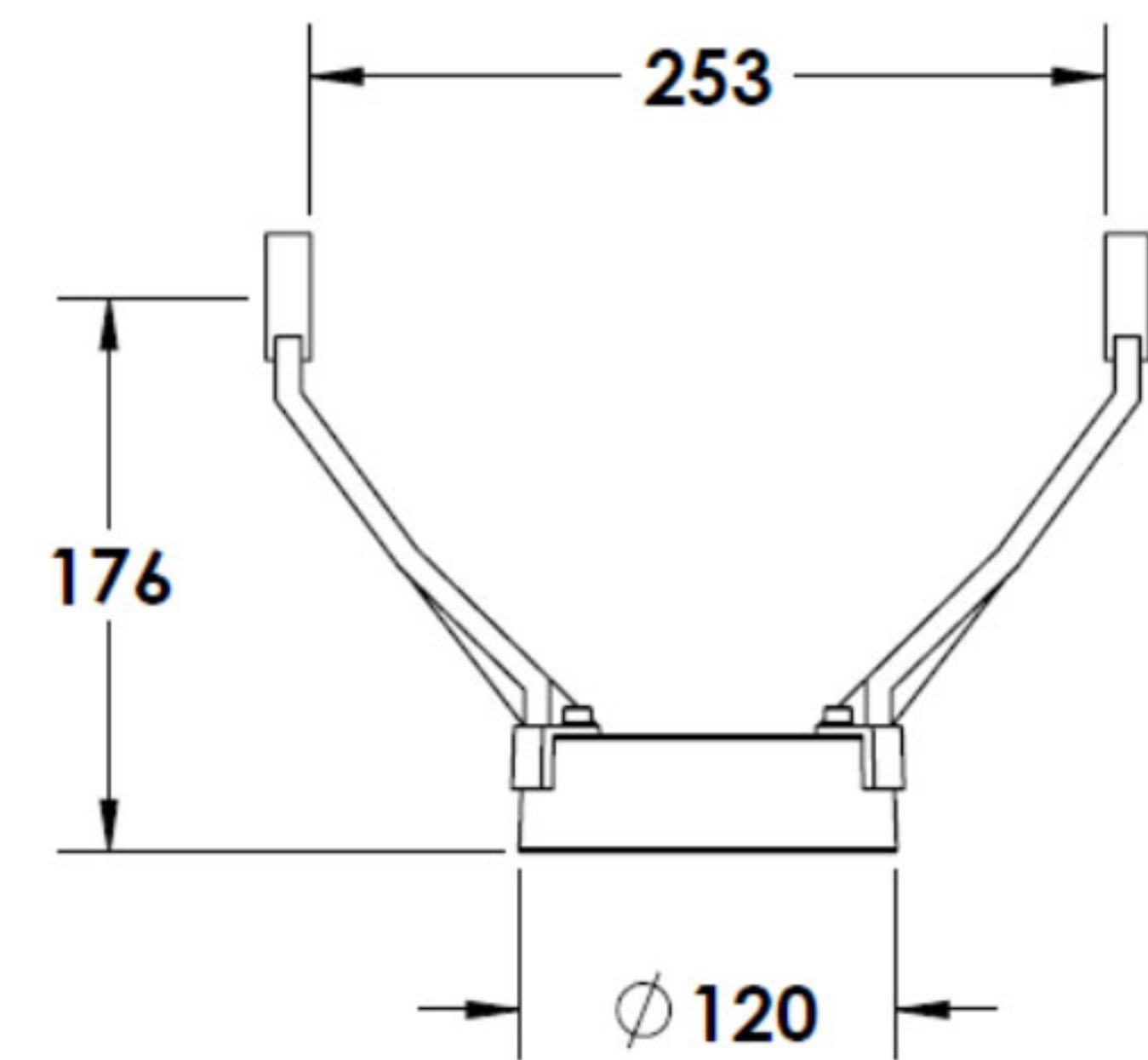

IP65 Gear Base
Powder coated die cast aluminium

P-ACC.B228.GB

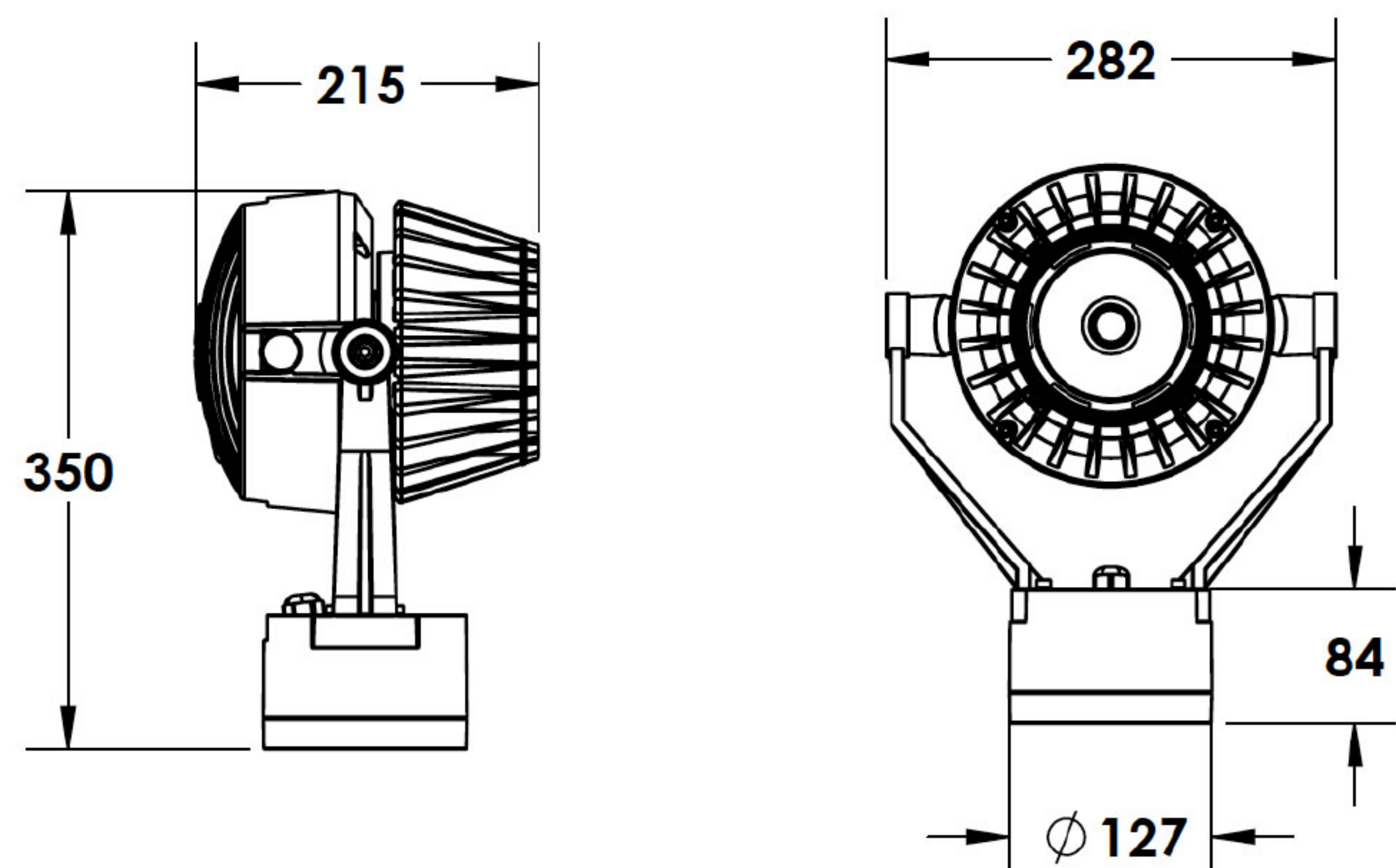

PJL03.2704.26.x.xx

Grünzell®

Optical Accessories

Snoot
Powder coated die cast aluminium

P-ACC.B228.SS

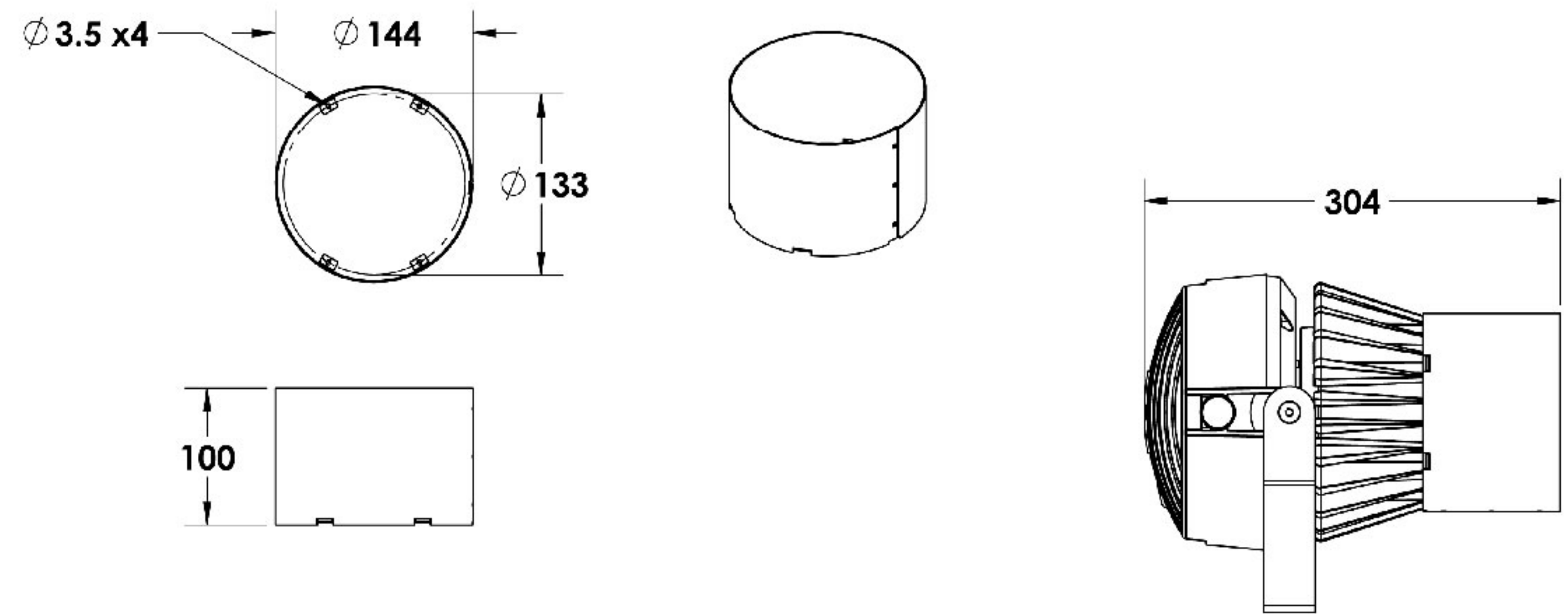

Glare Shield
Powder coated die cast aluminium

P-ACC.B228.GS

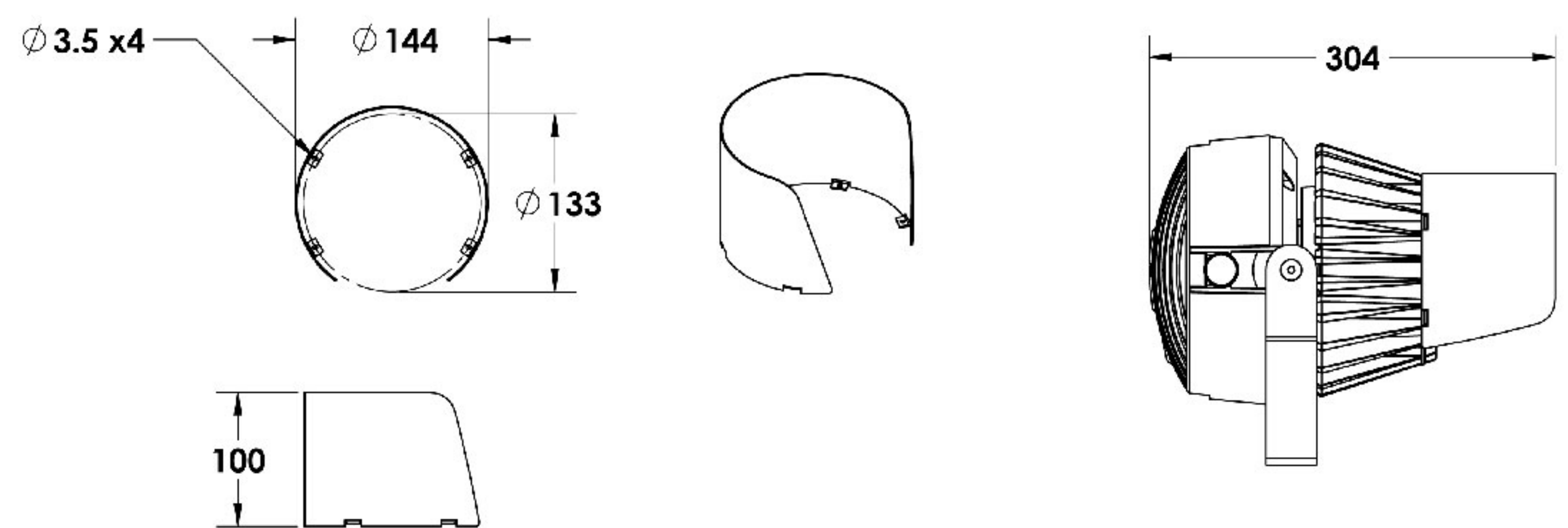

Visor
Powder coated die cast aluminium

P-ACC.B228.VS

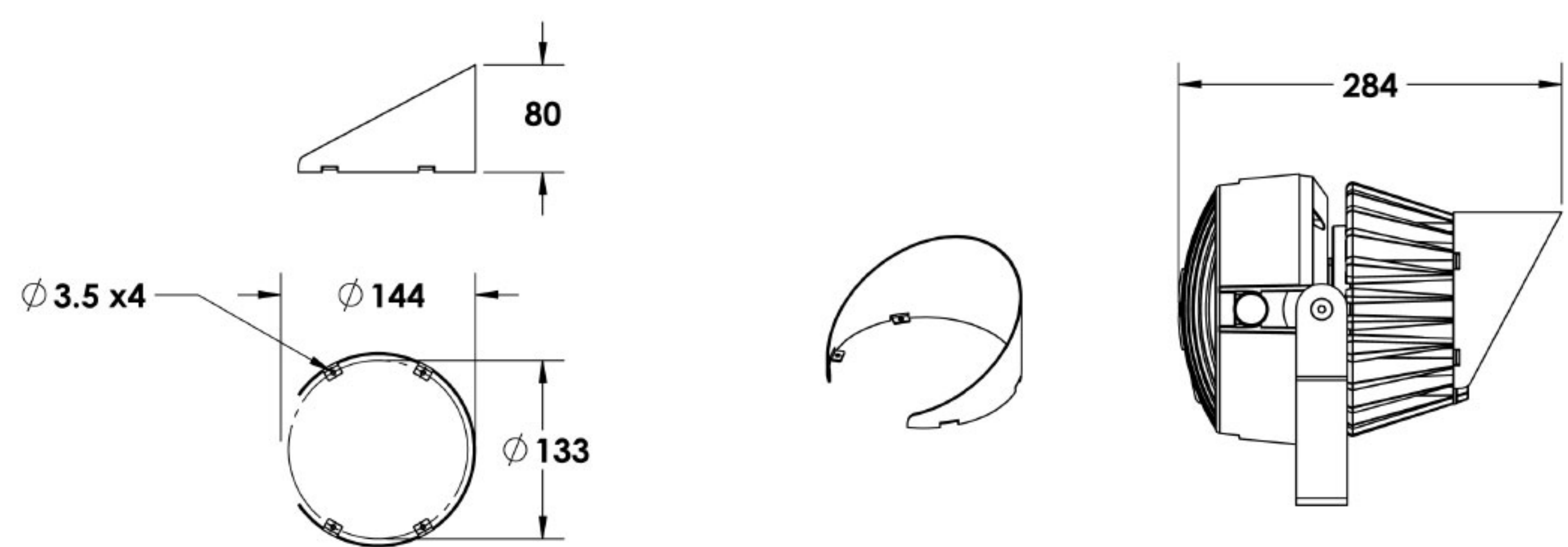

PJL03.2704.26.x.xx

Grünzell®

Optical Accessories

Linear Spreading Lens
Tempered Borosilicate Glass

P-ACC.B228.SL

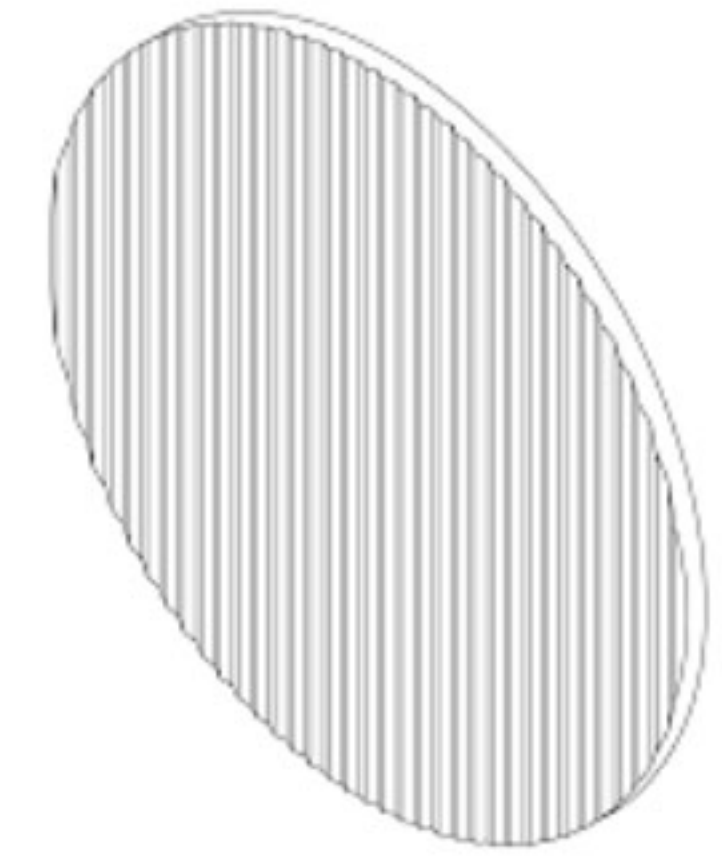

Glass Colour Filter (Red, Green or Blue)
other colour on request

P-ACC.B228.GF



IP65 Driver Box (for remote driver operation)
Powder coated aluminium

P-ACC.xxx.DB.xx

Options -:

- 1 input, 1 output channel
- 1 input, 2 output channel
- 1 input, 3 output channel

