

# PJL02.4001.56.x.xx

Grünzell®

## Description

IP65 Class I LED Projector with built in LED driver compartment thermally separated in a surface powder coated corrosion resistant die cast aluminium alloy housing. Featured GORE®Vent to protect the internal system from moisture. Silicon rubber gasket and stainless steel 316 screws. Highly specular reflector. Tempered glass cover. COB LED with socket.

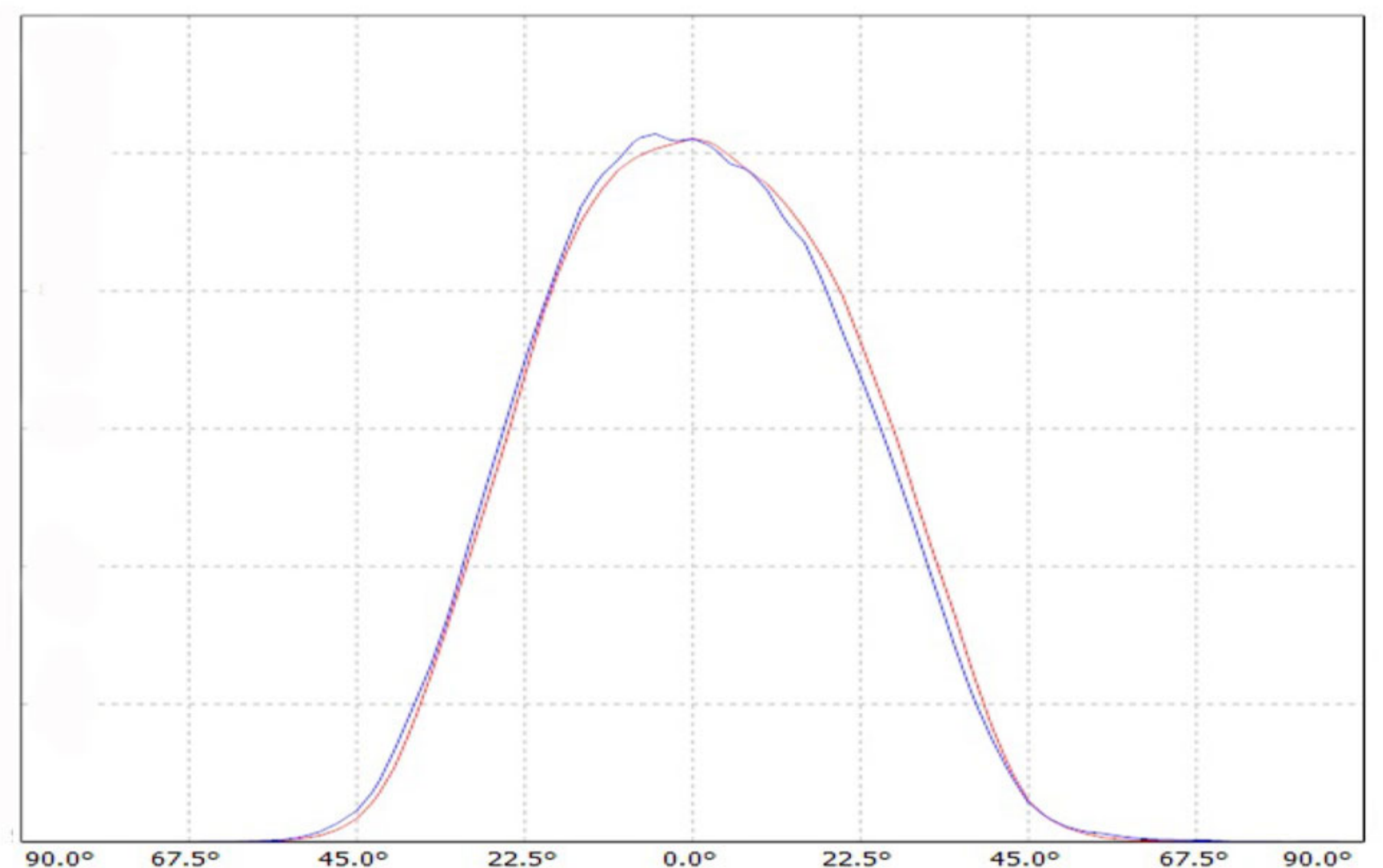
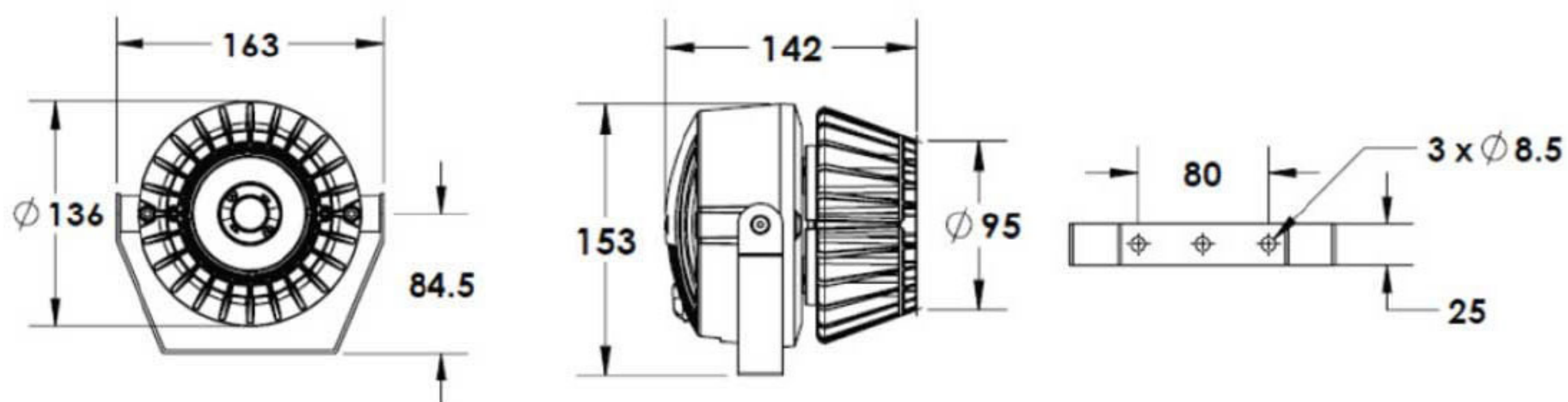

<b>LED Lamp</b>	1
<b>Luminous Flux</b>	1912 lm
<b>Colour temperature</b>	4000K
<b>CRI</b>	80
<b>Nominal Power</b>	14W
<b>Beam Angle</b>	56°

<b>Ingress Protection</b>	IP65
<b>Impact Protection</b>	IK08
<b>Body</b>	Die cast aluminium alloy
<b>Weight</b>	1.5kg
<b>Finish</b>	Power coat finish in white RAL9016, grey RAL9006 or black 9005
<b>Line Voltage</b>	100 ~ 270V / 50-60Hz
<b>Electrical Gear</b>	IP67 LED Driver in a thermally separated compartment



# PJL02.4001.56.x.xx

Grünzell®

## Mounting Accessories

Ground Spike  
Powder coated die cast aluminium

7218.005.01.02

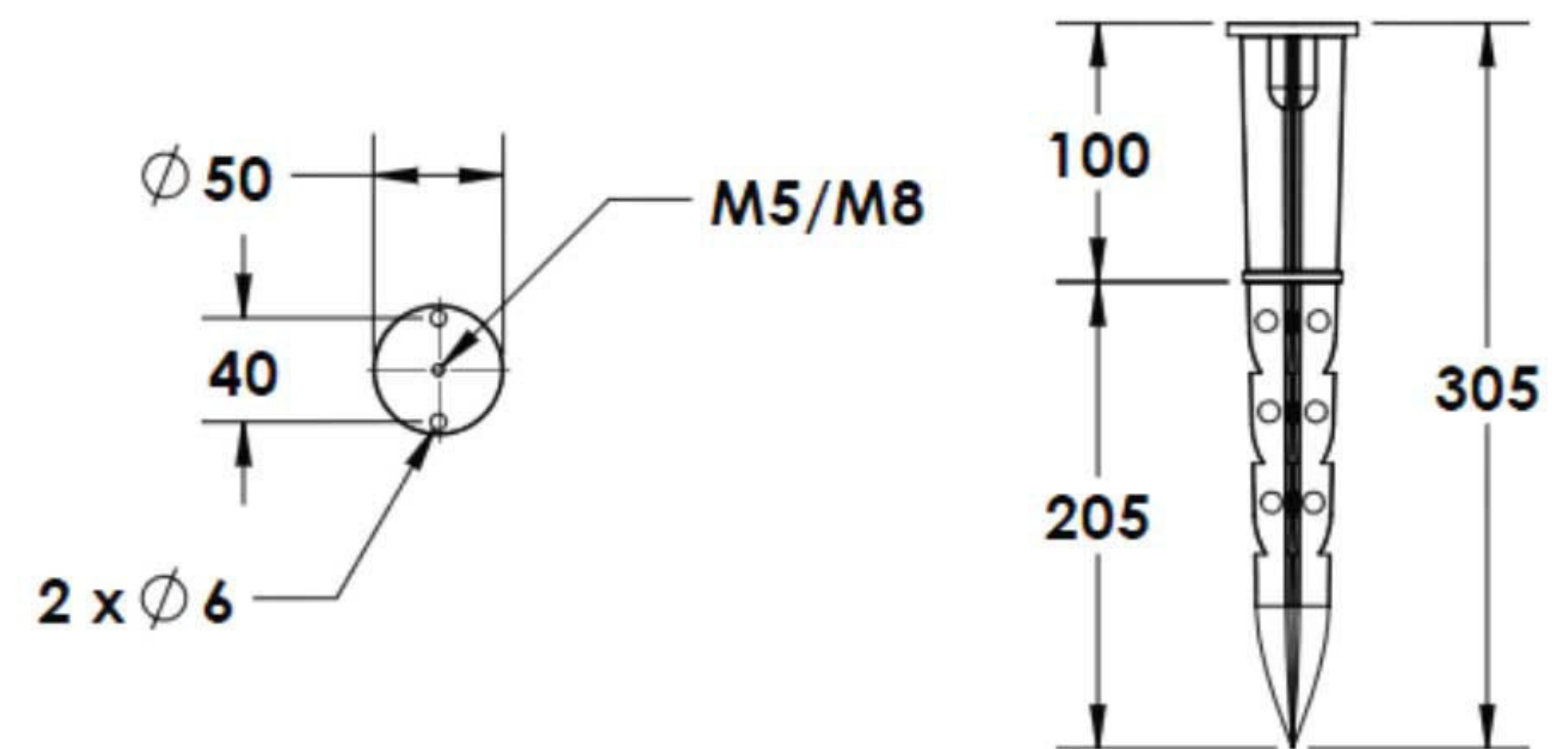

Cast Stirrup  
Powder coated die cast aluminium

7210.000.X2.xx

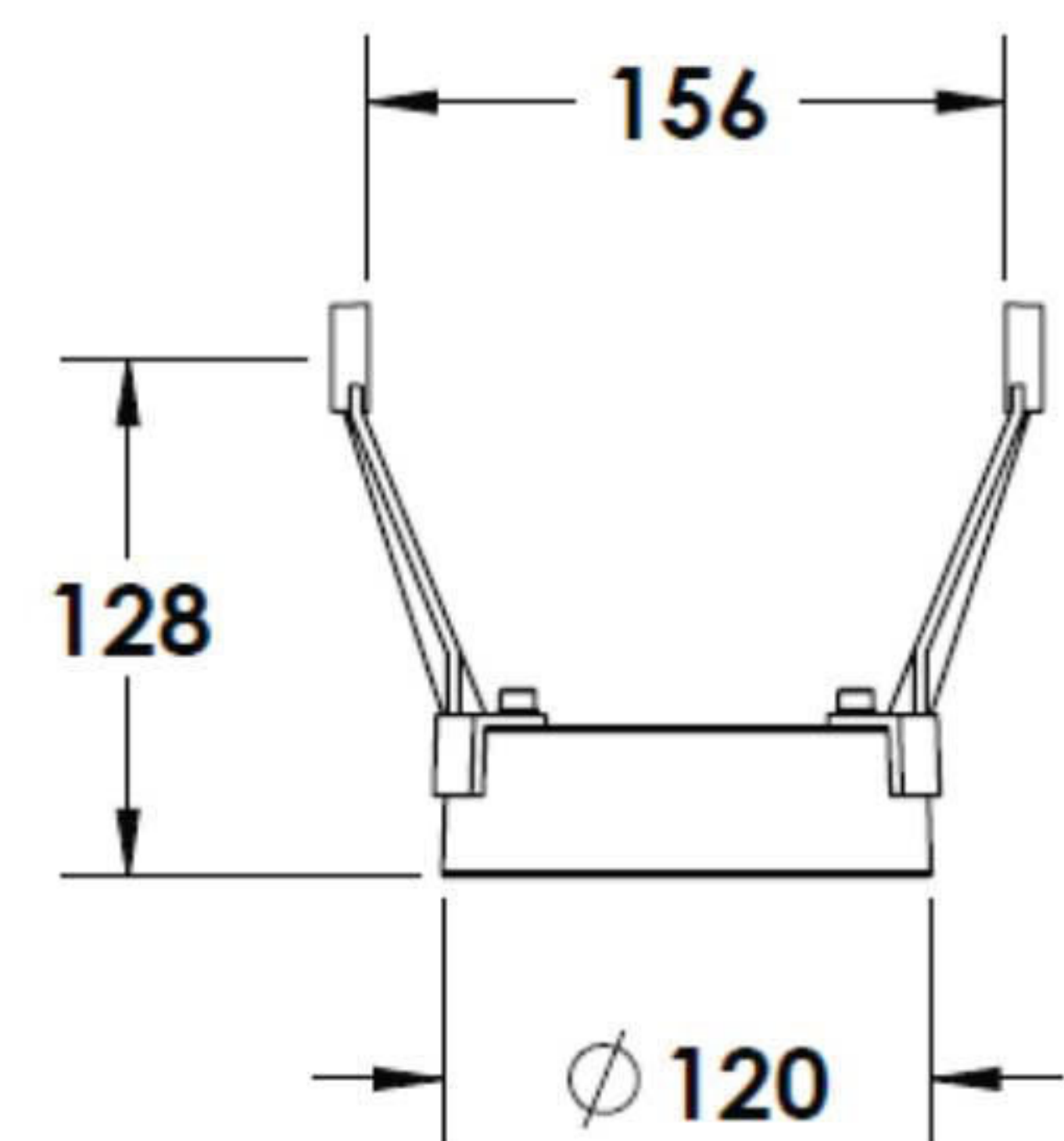

IP65 Gear Base  
Powder coated die cast aluminium

P-ACC.B218.GB

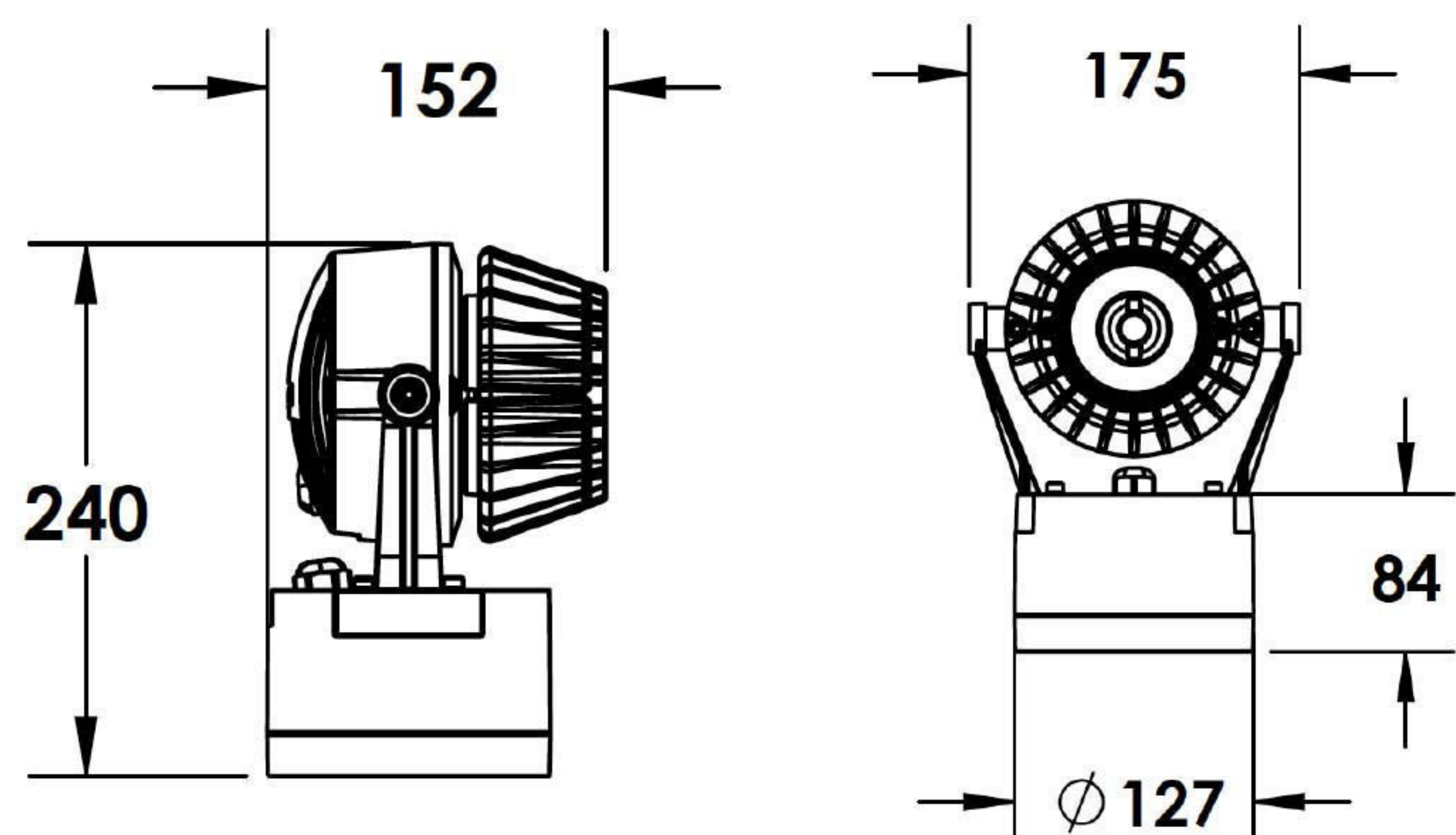



# PJL02.4001.56.x.xx

Grünzell®

## Optical Accessories

Snoot  
Powder coated die cast aluminium

P-ACC.B218.SS

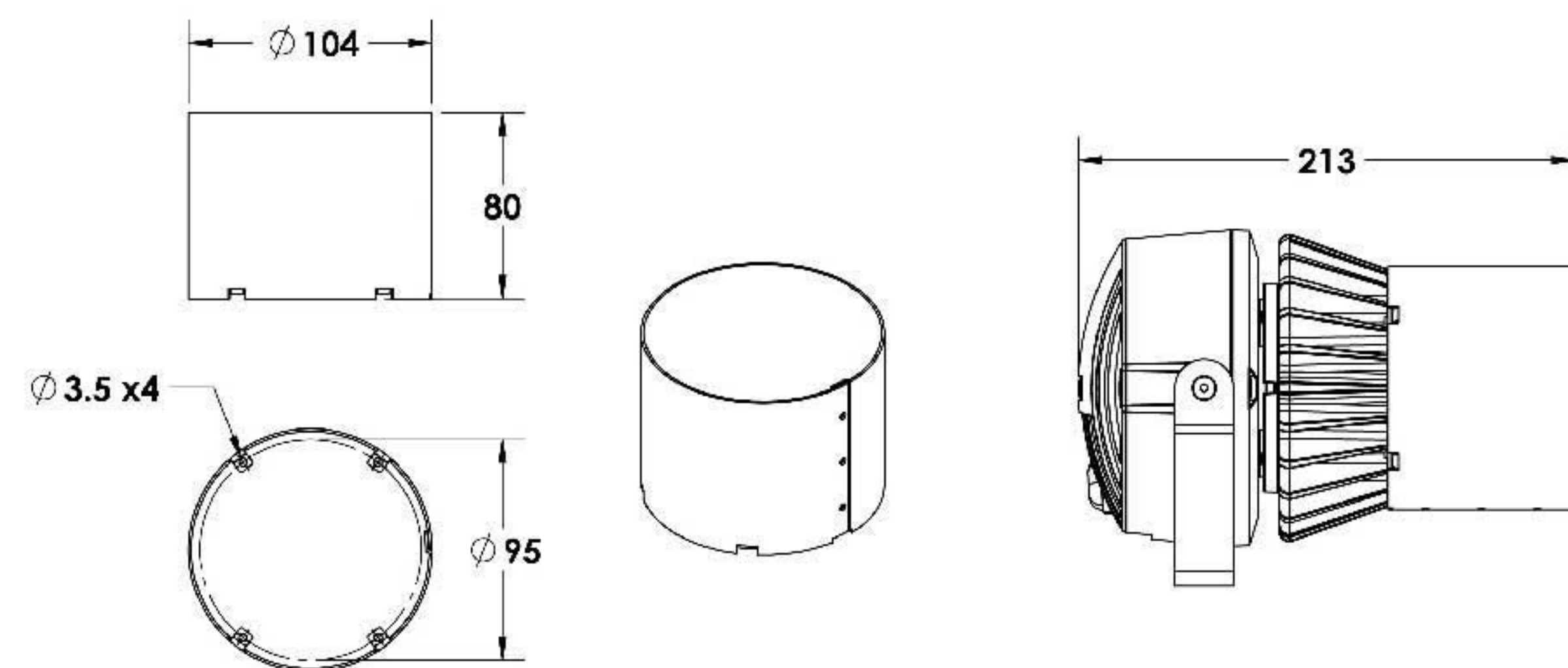

Glare Shield  
Powder coated die cast aluminium

P-ACC.B218.GS

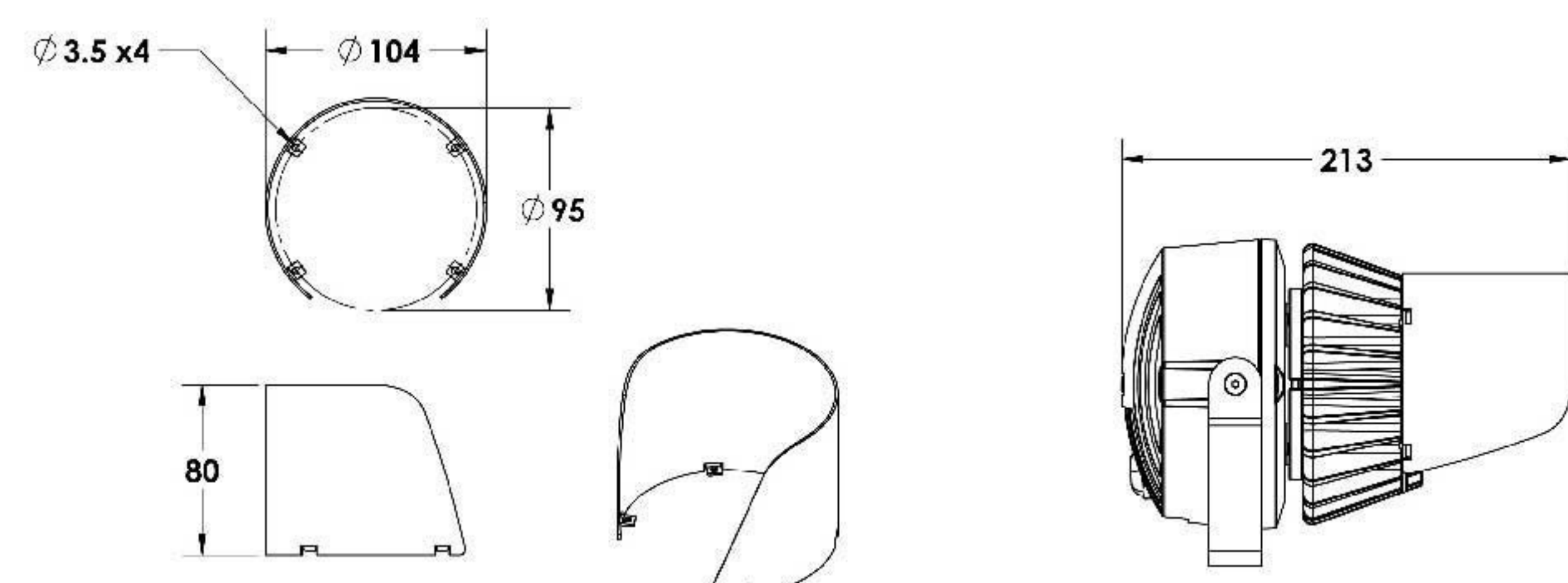

Visor  
Powder coated die cast aluminium

P-ACC.B218.VS

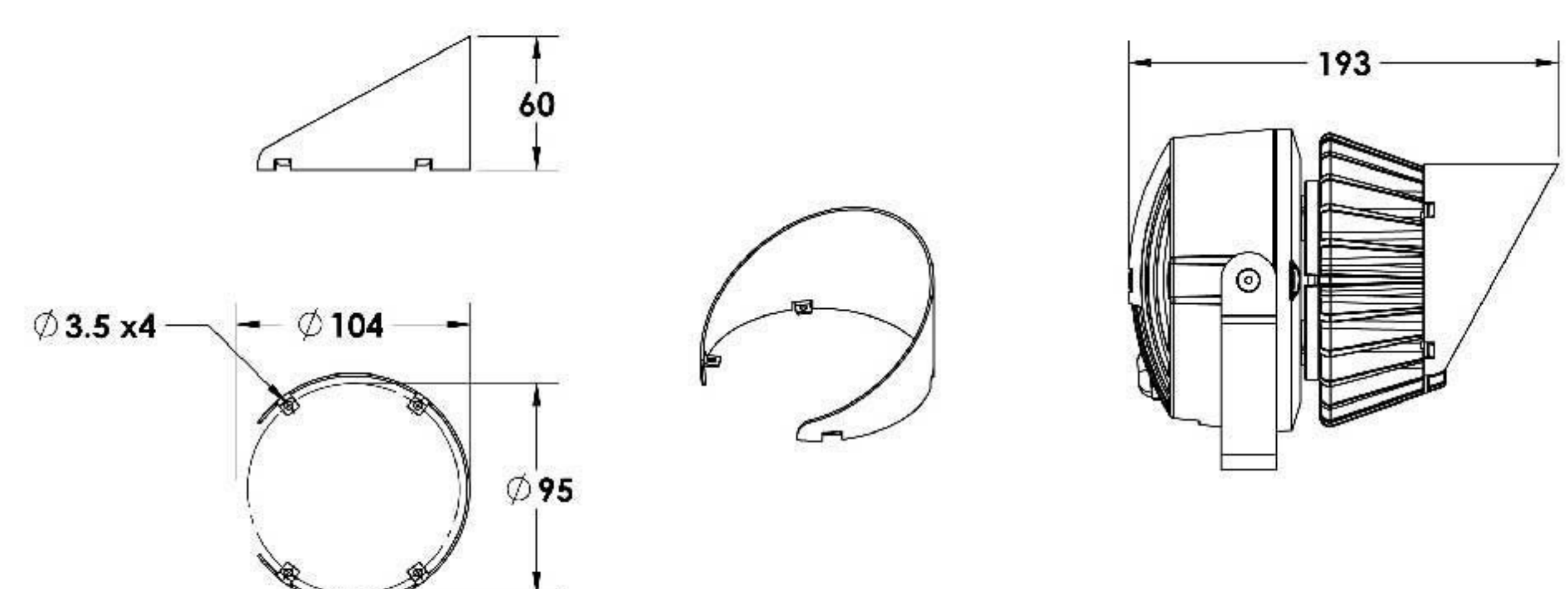



# PJL02.4001.56.x.xx



## Optical Accessories

Linear Spreading Lens  
Tempered Borosilicate Glass

P-ACC.B218.SL

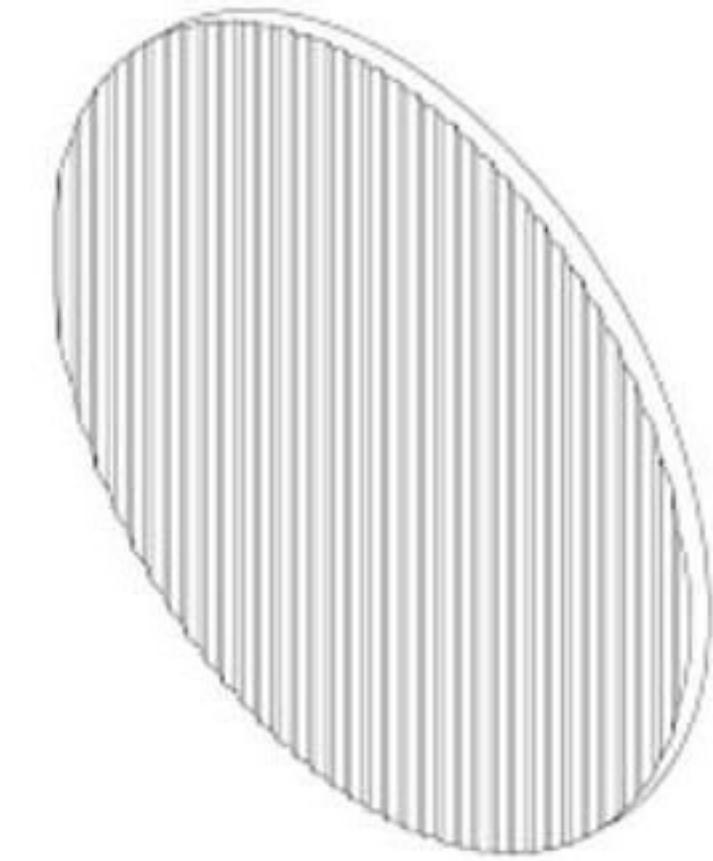

Glass Colour Filter (Red, Green or Blue)  
other colour on request

P-ACC.B218.GF



IP65 Driver Box (for remote driver operation)  
Powder coated aluminium

P-ACC.xxx.DB.xx

Options -:

- 1 input, 1 output channel
- 1 input, 2 output channel
- 1 input, 3 output channel

